

insert

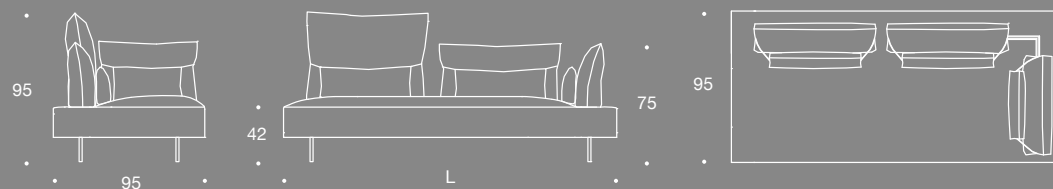

Dimensioni

Dimensions - Masse - Dimension - Tamaño



Profondità seduta 63 cm, senza poggiatesta - Seat depth 63 cm - Profondeur du siège 63 cm - Sitztiefe 63 cm - Profundidad del asiento 63 cm

Piedini

Metallo finitura in nichel-nero H 18 cm

Legs - Metal finished in black nickel H 18 cm

Fuesse - Métal finition nickel noir H 18 cm

Pieds - Metall Ausführung Nickel schwarz H 18

Pies - Metal con acabado de níquel negro H 18



Di serie

Standard - Standard

Standard - Estándar

Cuciture optional

Sewings - Naehste - Coutures - Costuras

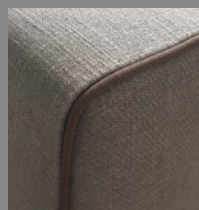

Bordo cannetè colorato

Piping with colored gross grain - Passepoil avec gross grain coloré - Keder mit buntem Gross Grain - cannetè coloreado

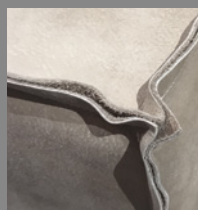

Bordo al vivo (pelle)

Open cut sewing (leather) - Couture ouverte (cuir) - Offenkantige Naht (Leder) - Costuras abiertas (cuero)



Filo cucitura contrasto (tessuto-pelle)

Sewing thread in contrasting color (fabric-leather) - Fil couture contrastant (tissu et cuir) - Naht in Kontrastfarbe (Stoff-Leder) - Costura con color de contraste



Chiusa

Closed Feste Naht - Couture fermée - Costura cerrada

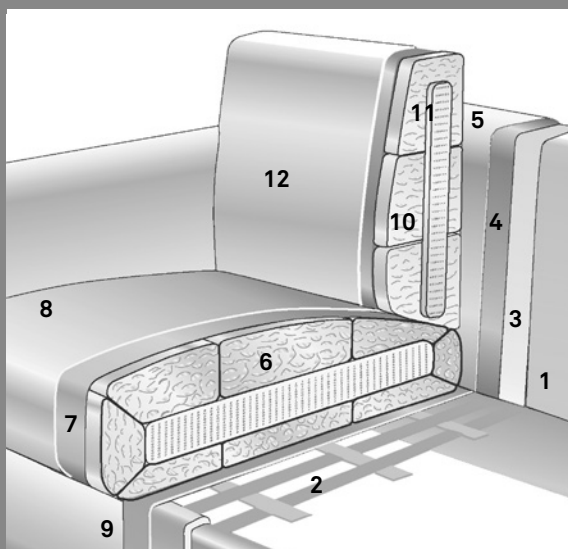

Struttura

Structure - Struktur
Structure - Estructura

1. Fusto legno

Wood structure - Structure en bois
Holzstruktur - Estructura de madera

2. Cinghia elastica

Belts - Elastische Gurte
Sangles élastiques - Correas elásticas

3. Gomma

Foam - Poliurethanschaum
Mousse - Poliuretano

4. Rivestimento

Cover - Bezug - Housse
Revestimiento

5. Tessuto

Fabric - Stoff - Tissu - Tela

Cuscino seduta

Seat cushion - Sitzkissen
Coussin de siège - Cojín del asiento

6. Gomma a quote differenziate a bassa deformazione

Differentiated thickness polyurethane foam - Mousse de Polyuréthane avec densités différentes - Polyurethanschaum mit unterschiedlicher Dichte - Goma en Polyurethan con diferentes densidades

7. Resinato

Resinate - Harzschaum
Resine mousse - Resina de goma

8. Tessuto

Fabric - Stoff - Tissu - Tela

Cuscino schienale

Back cushion - Rueckenkissen
Coussins de dossier - Cojines de respaldo

9. Struttura in ferro verniciato con cinghie elastiche

Painted iron structure - Structure en fer peint - Struktur in lackiertem Eisen
Estructura de hierro pintado

10. Gomma performance a bassa deformazione

Low deformation polyurethane foam performance - Mousse performance a déformation faible - Polyurethanschaum mit niedriger Deformationsquote - Rendimiento de la goma a baja deformación











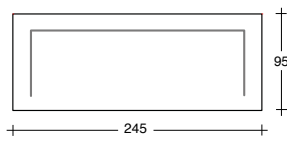



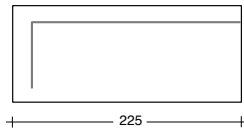



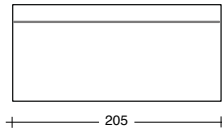



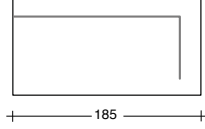



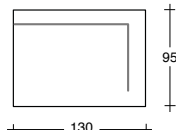



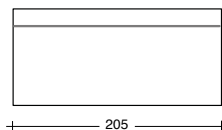

11. Misto piuma sterilizzata e siliconata

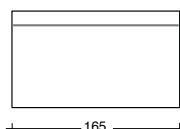
Sterilized and siliconized feather Mix
Stérilisés et siliconés mix des plumes
Sterilisierte und mit Silikon behandelte Feder Mischung - Mix de pluma esterilizada y silicona

12. Tessuto

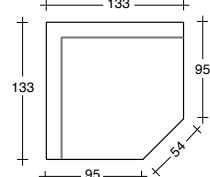
Fabric - Stoff - Tissu - Tela

insert

	<p>G901 Divano cm 245 Sofa cm 245 Canapé cm 245 Sofa cm 245 Sofa cm 245</p>	 kg  m ³ 0,80  m 6	<p>Fodera di ricambio SpareCover Housse deréchange Ersatzbezug Funda</p>
 <p>sx-left</p>	<p>G903 Laterale cm 225 Lateral cm 225 Laterale cm 225 Seitenelement cm 225</p> <p>G902 Lateral cm 225 Lateral cm 225</p> <p>dx-right</p>	 kg  m ³ 0,75  m 5,70	<p>Fodera di ricambio SpareCover Housse deréchange Ersatzbezug Funda</p>
	<p>G904 Divano cm 205 Sofa cm 205 Canapé cm 205 Sofa cm 205 Sofa cm 205</p>	 kg  m ³ 0,70  m 5	<p>Fodera di ricambio SpareCover Housse deréchange Ersatzbezug Funda</p>
 <p>dx-right</p>	<p>G907 Laterale cm 185 Lateral cm 185 Laterale cm 185 Seitenelement cm 185</p> <p>G906 Lateral cm 185 Lateral cm 185</p> <p>dx-right</p>	 kg  m ³ 0,65  m 4,70	<p>Fodera di ricambio SpareCover Housse deréchange Ersatzbezug Funda</p>
 <p>dx-right</p>	<p>G909 Laterale cm 130 Lateral cm 130 Laterale cm 130 Seitenelement cm 130</p> <p>G908 Lateral cm 130 Lateral cm 130</p> <p>dx-right</p>	 kg  m ³ 0,45  m 3,50	<p>Fodera di ricambio SpareCover Housse deréchange Ersatzbezug Funda</p>
	<p>G910 Centrale cm. 205 Central element cm 205 Centrale cm 205 Mittel Element cm 205 Elemento central cm 205</p>	 kg  m ³ 0,70  m 5	<p>Fodera di ricambio SpareCover Housse deréchange Ersatzbezug Funda</p>
	<p>G911 Centrale cm. 165 Central element cm 165 Centrale cm 165 Mittel Element cm 165 Elemento central cm 165</p>	 kg  m ³ 0,55  m 4,40	<p>Fodera di ricambio SpareCover Housse deréchange Ersatzbezug Funda</p>
	<p>G914 Elemento angolare cm 133x133 Corner element cm 133x133</p>	 kg  m ³ 0,65  m 4,50	<p>Fodera di ricambio SpareCover Housse deréchange Ersatzbezug Funda</p>

insert

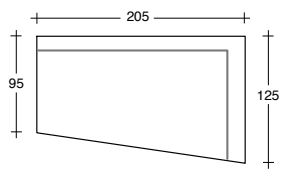

dx-right

G913 **Penisola obliqua cm 205**
 sx-left
 Peninsula cm 205
 Peninsule cm 205
G912 **Halbinsel cm 205**
 dx-right
 Halbinsel cm 205
 Peninsula cm 205



kg



m³ 0,90



m 5

Fodera di ricambio
 SpareCover
 Housse deréchange
 Ersatzbezug
 Funda

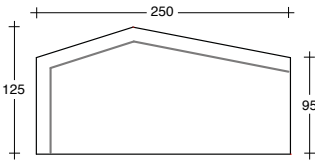

sx-left

G917 **Penisola sagomata cm 250x125**
 sx-left
 Peninsula
 Peninsule
G918 **Halbinsel**
 dx-right
 Peninsula



kg



m³ 1,10



m 6

Fodera di ricambio
 SpareCover
 Housse deréchange
 Ersatzbezug
 Funda

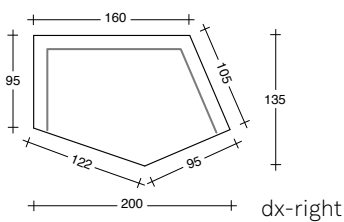

dx-right

G915 **Isola cm 200X135**
 sx-left
 Isle DX 200X135
 Ilot DX 200X135
 Insel DX 200X135
G916 **Isla DX 200X135**
 dx-right



kg



m³ 0,95



m 5,50

Fodera di ricambio
 SpareCover
 Housse deréchange
 Ersatzbezug
 Funda

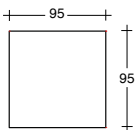

G919 **Pouf 95x95**
 Pouf 95x95
 Pouf 95x95
 Hocker 95x95
 Pouf 95x95



kg



m³ 1,35



m 2,50

Fodera di ricambio
 SpareCover
 Housse deréchange
 Ersatzbezug
 Funda

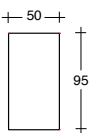

G920 **Pouf 50x95**
 Pouf 50x95
 Pouf 50x95
 Hocker 50x95
 Pouf 50x95



kg



m³ 1,15



m 2

Fodera di ricambio
 SpareCover
 Housse deréchange
 Ersatzbezug
 Funda

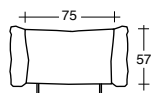

G921 **Schienale cm 75xh57**
 Backrest cushion
 Coussin de dos
 Rueckenkissen
 Cojines des respaldo



kg



m³ 0,15



m 1,60

Fodera di ricambio
 SpareCover
 Housse deréchange
 Ersatzbezug
 Funda

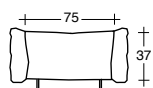

G922 **Bracciolo schienale basso cm 75xh37**
 Arm-Backrest low
 Accoudoir-dos bas
 Arm-Rückenlehne niedrig
 Apoyabrazos-respaldo bajo



kg



m³ 0,13



m 1,50

Fodera di ricambio
 SpareCover
 Housse deréchange
 Ersatzbezug
 Funda

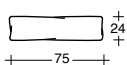

G923 **Poggiareni cm 75x24**
 Lumbar cushions
 Coussins lombaires
 Nierenkissen
 Cojines lumbares



kg



m³



m 0,80

Fodera di ricambio
 SpareCover
 Housse deréchange
 Ersatzbezug
 Funda

insert

Composizione - Composition - Composition - Gruppe - Composición C1

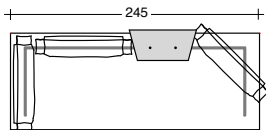

- G901** **Divano cm 245**
Sofa cm 245
- G921** **3 Cuscino schienale cm 75xh57**
3 High backrest cushion cm 75xh57
- G926** **Tavolino con finitura Eucalipto cm 30x66/50xh3**
Table finishing Eucalyptus cm 30x66/50xh3

Composizione - Composition - Composition - Gruppe - Composición C2

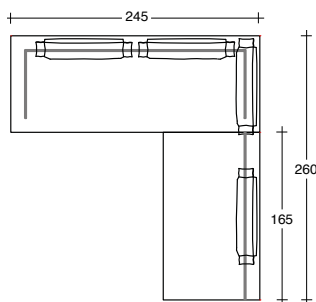

- G901** **Divano cm 245**
Sofa cm 245
- G911** **Centrale cm 165**
Central element cm 165
- G921** **4 Cuscino schienale cm 75xh57**
4 High backrest cushion cm 75xh57

Composizione - Composition - Composition - Gruppe - Composición C3

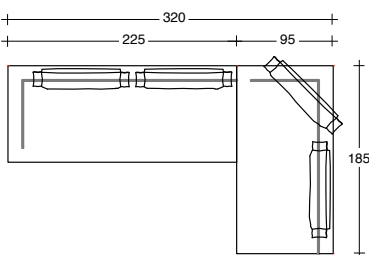

- G903 sx** **Laterale 225 cm**
Lateral 225 cm
- G907sx** **Laterale 185 cm**
Lateral 185 cm
- G921** **4 Cuscino schienale cm 75xh57**
4 High backrest cushion cm 75xh57

Composizione - Composition - Composition - Gruppe - Composición C4

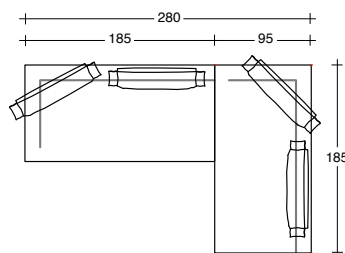

- G907 sx** **2 Laterale 185 cm**
2 Lateral 185 cm
- G921** **4 Cuscino schienale cm 75xh57**
4 High backrest cushion cm 75xh57

insert

Composizione - Composition - Composition - Gruppe - Composición C5

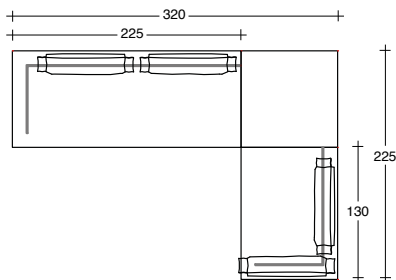

- G903 sx** Laterale cm 225
Lateral cm 225
- G908 dx** Laterale cm 130
Lateral cm 130
- G919** Pouf 95x95
Pouf 95x95
- G921** 4 Cuscino schienale cm 75xh57
4 High backrest cushion cm 75xh57

Composizione - Composition - Composition - Gruppe - Composición C6

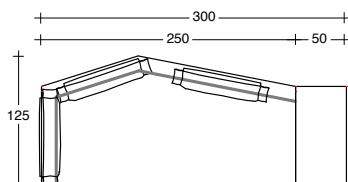

- G917 sx** Penisola sagomata cm 250x125
Peninsula cm 250x125
- G920** Pouf 50x95
Pouf 50x95
- G921** 3 Cuscino schienale cm 75xh57
3 High backrest cushion cm 75xh57

Composizione - Composition - Composition - Gruppe - Composición C7

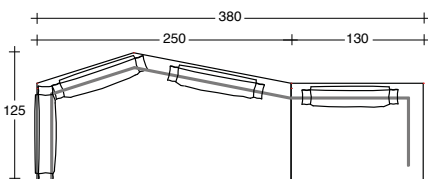

- G917sx** Penisola sagomata cm 250x125
Peninsula cm 250x125
- G908 dx** Laterale cm 130
Lateral cm 130
- G921** 4 Cuscino schienale cm 75xh57
4 High backrest cushion cm 75xh57

Composizione - Composition - Composition - Gruppe - Composición C8

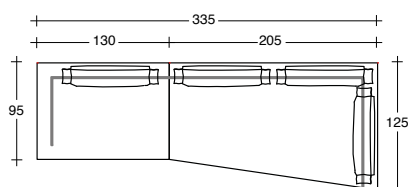

- G912dx** Penisola obliqua cm 205
Peninsula cm 250x125
- G909 sx** Laterale cm 130
Lateral cm 130
- G921** 4 Cuscino schienale cm 75xh57
4 High backrest cushion cm 75xh57

insert

Composizione - Composition - Composition - Gruppe - Composición C9

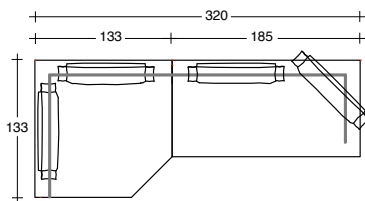

- G906 dx** Laterale cm 185
Lateral cm 185
- G914** Elemento angolare cm 133x133
Corner element cm 133x133
- G921** 4 Cuscino schienale cm 75xh57
4 High backrest cushion cm 75xh57

Composizione - Composition - Composition - Gruppe - Composición C10

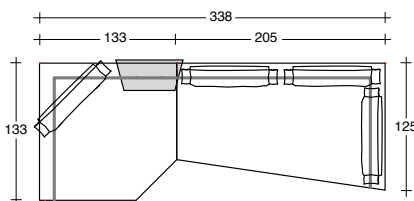

- G912 dx** Penisola obliqua cm 205
Peninsula cm 205
- G914** Elemento angolare cm 133x133
Corner element cm 133x133
- G921** 4 Cuscino schienale cm 75xh57
4 High backrest cushion cm 75xh57
- G926** Tavolino con finitura Eucalipt cm 30x66/50xh3
Table finishing Eucalyptus cm 30x66/50xh3

Composizione - Composition - Composition - Gruppe - Composición C11

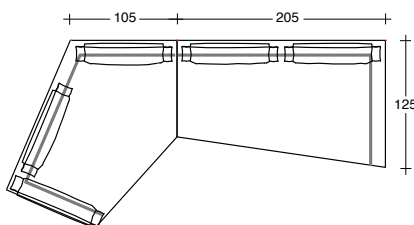

- G912 dx** Penisola obliqua cm 205
Peninsula cm 205
- G916 dx** Isola cm 200x135
Isola cm 200x135
- G921** 4 Cuscino schienale cm 75xh57
4 High backrest cushion cm 75xh57
- G922** Cuscino bracciolo/schienale basso cm 75xh37
Arm-Backrest low

Composizione - Composition - Composition - Gruppe - Composición C12

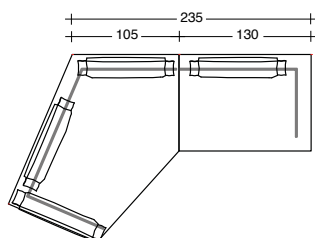

- G908 dx** Laterale cm 130
Lateral cm 130
- G916 dx** Isola cm 200x135
Isola cm 200x135
- G921** 4 Cuscino schienale cm 75xh57
4 High backrest cushion cm 75xh57

insert

Composizione - Composition - Composition - Gruppe - Composición C13

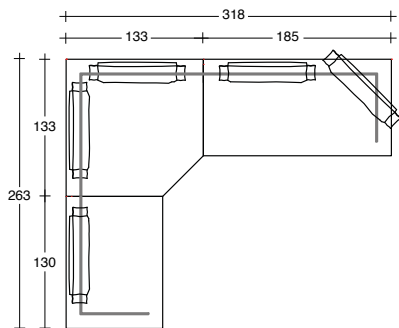

- G906 dx** Laterale cm 185
Lateral cm 185
- G914** Elemento angolare cm 133x133
Corner element cm 133x133
- G909 sx** Laterale cm 130
Lateral cm 130
- G921** 4 Cuscino schienale cm 75xh57
4 High backrest cushion cm 75xh57
- G922** Cuscino bracciolo/schienale basso cm 75xh37
Arm-Backrest low

Composizione - Composition - Composition - Gruppe - Composición C14

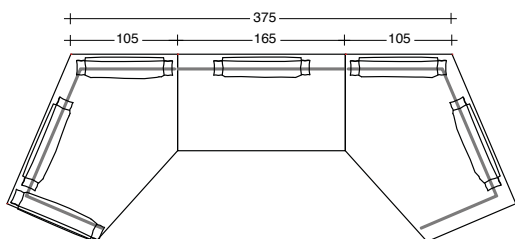

- G916 dx** Isola cm 200x135
Isola cm 200x135
- G915 sx** Isola cm 200x135
Isola cm 200x135
- G911** Centrale cm 165
Central cm 165
- G921** 5 Cuscino schienale cm 75xh57
5 High backrest cushion cm 75xh57
- G922** Cuscino bracciolo/schienale basso cm 75xh37
Arm-Backrest low