

# artur

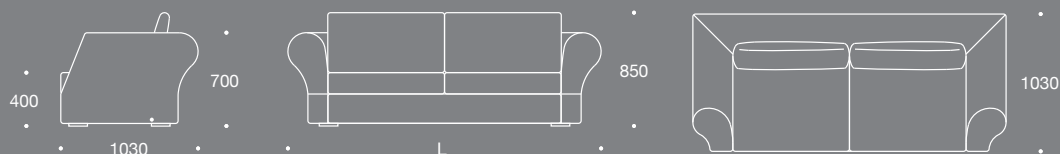

## Dimensioni

Dimensions - Masse - Dimension - Tamaño



## Piedini

Finitura legno

**Legs** - Wood finishing

**Fuesse** - Bois finition

**Pieds** - Ausführung in Holz

**Pies** - Acabado de madera



## Di serie

Standard - Standard

Standard - Estándar

## Cuciture optional

Sewings - Naehete - Coutures - Costuras



### Bordo canneté colorato

Piping with colored gross grain - Passepoil avec gross grain coloré - Keder mit buntem Gross Grain - canneté coloreado



### Bordo al vivo (pelle)

Open cut sewing (leather) - Couture ouverte (cuir) - Offenkantige Naht (Leder) - Costuras abiertas (cuero)



### Taglio vivo con cucitura rovesciata (pelle)

Open cut inverted sewing (leather) - Couture ouverte invertie (cuir) - Offenkantige umgekehrte Naht (Leder) - Costuras abiertas volcadas (cuero)

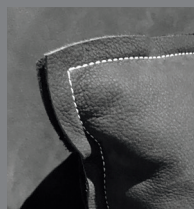

### Filo cucitura contrasto (tessuto-pelle)

Sewing thread in contrasting color (fabric-leather) - Fil couture contrastant (tissu et cuir) - Naht in Kontrastfarbe (Stoff-Leder) - Costura con color de contraste



### Chiusa

Closed Feste Naht Couture fermée Costura cerrada

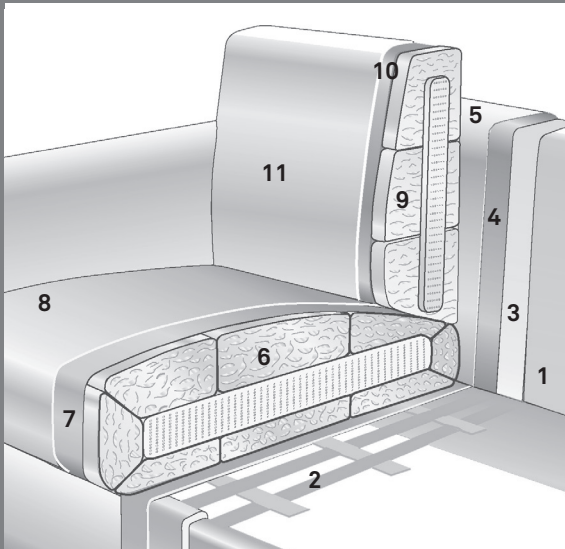

## Struttura

Structure - Struktur  
Structure - Estructura

### 1. Fusto legno

Wood structure - Structure en bois  
Holzstruktur - Estructura de madera

### 2. Cinghia elastica

Belts - Elastische Gurte  
Sangles élastiques - Correas elásticas

### 3. Gomma

Foam - Poliurethanschaum  
Mousse - Poliuretano

### 4. Rivestimento

Cover - Bezug - Housse  
Revestimiento

### 5. Tessuto

Fabric - Stoff - Tissu - Tela

## Cuscino seduta

Seat cushion - Sitzkissen  
Coussin de siège - Cojín del asiento

### 6. Gomma performance a bassa deformazione

Low deformation polyurethane foam performance - Mousse performance a déformation faible - Polyurethanschaum mit niedriger Deformationsquote - Rendimiento de la goma a baja deformación

### 7. Resinato

Resinate - Harzschaum  
Resine mousse - Resina de goma

### 8. Tessuto

Fabric - Stoff - Tissu - Tela

## Cuscino schienale

Back cushion - Rueckenkissen  
Coussins de dossier - Cojines de respaldo

### 9. Misto piuma sterilizzata e siliconata

Sterilized and siliconized feather Mix  
Stérilisés et siliconés mix des plumes  
Sterilisierte und mit Silikon behandelte Federmischung - Mix de pluma esterilizada y silicona











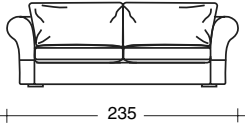



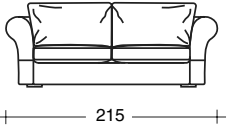



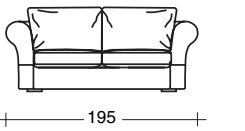



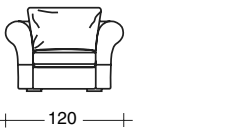



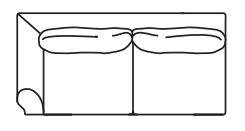



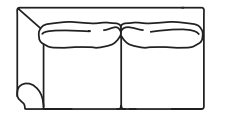

### 10. Resinato

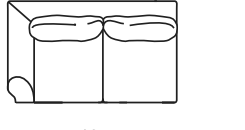



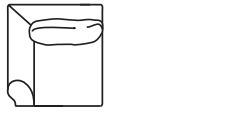





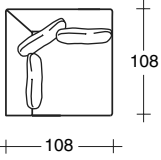



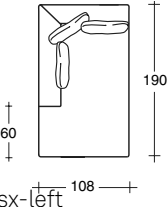



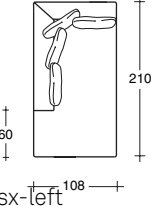



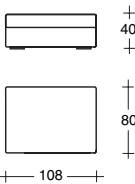



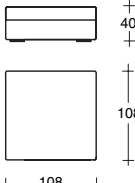

Resinate - Harzschaum  
Resine mousse - Resina de goma

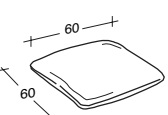
### 11. Tessuto

Fabric - Stoff - Tissu - Tela

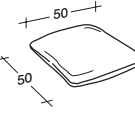
# artur

 <p>235</p>	<p><b>E201</b> <b>Divano 3 posti</b> Sofa 3 seaters Canapé 3 places Sofa 3-Sitzer Sofa 3 asientos</p>	 kg 75	 m <sup>3</sup> 2,1	 m 15,5	<p><b>Fodera di ricambio</b> SpareCover Housse deréchange Ersatzbezug Funda</p>
 <p>215</p>	<p><b>E202</b> <b>Divano medio</b> Sofa medium Canapé medium Sofa medium Sofa medio</p>	 kg 68	 m <sup>3</sup> 1,8	 m 15	<p><b>Fodera di ricambio</b> SpareCover Housse deréchange Ersatzbezug Funda</p>
 <p>195</p>	<p><b>E203</b> <b>Divano 2 posti</b> Sofa 2 seaters Canapé 2 places Sofa 2-Sitzer Sofa 2 asientos</p>	 kg 62	 m <sup>3</sup> 1,7	 m 14	<p><b>Fodera di ricambio</b> SpareCover Housse deréchange Ersatzbezug Funda</p>
 <p>120</p>	<p><b>E204</b> <b>Poltrona</b> Armchair Fauteuil Sessel Butaca</p>	 kg 50	 m <sup>3</sup> 1,4	 m 9	<p><b>Fodera di ricambio</b> SpareCover Housse deréchange Ersatzbezug Funda</p>
 <p>205</p> <p>sx-left</p>	<p><b>E205</b> <b>Laterale 3 posti</b> Lateral 3 seaters Laterale 3 places Seitenelement 3-Sitzer Laterale 3 asientos</p> <p><b>E206</b> dx-right</p>	 kg 65	 m <sup>3</sup> 1,9	 m 14	<p><b>Fodera di ricambio</b> SpareCover Housse deréchange Ersatzbezug Funda</p>
 <p>185</p> <p>sx-left</p>	<p><b>E207</b> sx-left</p> <p><b>E208</b> dx-right</p> <p><b>Laterale medio</b> Lateral medium Laterale medium Seitenelement medium Lateral medio</p>	 kg 62	 m <sup>3</sup> 1,85	 m 13	<p><b>Fodera di ricambio</b> SpareCover Housse deréchange Ersatzbezug Funda</p>
 <p>165</p> <p>sx-left</p>	<p><b>E209</b> sx-left</p> <p><b>E210</b> dx-right</p> <p><b>Laterale 2 posti</b> Lateral 2 seaters Laterale 2 places Seitenelement 2-Sitzer Laterale 2 asientos</p>	 kg 60	 m <sup>3</sup> 1,6	 m 12	<p><b>Fodera di ricambio</b> SpareCover Housse deréchange Ersatzbezug Funda</p>
 <p>95</p> <p>sx-left</p>	<p><b>E211</b> sx-left</p> <p><b>E212</b> dx-right</p> <p><b>Laterale 1 posto</b> Lateral 1 seat Laterale 1 place Seitenelement 1 Sitzer Laterale 1 asiento</p>	 kg 40	 m <sup>3</sup> 1,15	 m 8,5	<p><b>Fodera di ricambio</b> SpareCover Housse deréchange Ersatzbezug Funda</p>

	<p><b>E213</b> <b>Angolo</b>            Corner            Angle            Ecke            Esquina</p>	 kg 45  m <sup>3</sup> 1,15  m 10	<p><b>Fodera di ricambio</b>            SpareCover            Housse deréchange            Ersatzbezug            Funda</p>
	<p><b>E215</b> <b>Penisola cm 190</b>            Peninsula cm 190            Peninsule cm 190            Halbinsel cm 190  <b>E214</b> Peninsula cm 190            dx-right</p>	 kg 61  m <sup>3</sup> 1,6  m 14	<p><b>Fodera di ricambio</b>            SpareCover            Housse deréchange            Ersatzbezug            Funda</p>
	<p><b>E217</b> <b>Penisola cm 210</b>            Peninsula cm 210            Peninsule cm 210            Halbinsel cm 210  <b>E216</b> Peninsula cm 210            dx-right</p>	 kg 64  m <sup>3</sup> 1,9  m 14	<p><b>Fodera di ricambio</b>            SpareCover            Housse deréchange            Ersatzbezug            Funda</p>
	<p><b>E219</b> <b>Pouf 108x80</b>            Pouf 108x80            Pouf 108x80            Hocker 108x80            Pouf 108x80</p>	 kg 25  m <sup>3</sup> 0,35  m 4	<p><b>Fodera di ricambio</b>            SpareCover            Housse deréchange            Ersatzbezug            Funda</p>
	<p><b>E218</b> <b>Pouf 108x108</b>            Pouf 108x108            Pouf 108x108            Hocker 108x108            Pouf 108x108</p>	 kg 28  m <sup>3</sup> 0,50  m 4	<p><b>Fodera di ricambio</b>            SpareCover            Housse deréchange            Ersatzbezug            Funda</p>
	<p><b>F226</b> <b>Cuscino 60x60</b>            Cushion 60x60            Coussin 60x60            Kissen 60x60            Cojin 60x60</p>	 kg 0,90  m <sup>3</sup> 0,40  m 0,90	<p><b>Fodera di ricambio</b>            SpareCover            Housse deréchange            Ersatzbezug            Funda</p>
	<p><b>F227</b> <b>Cuscino 50x50</b>            Cushion 50x50            Coussin 50x50            Kissen 50x50            Cojin 50x50</p>	 kg 0,70  m <sup>3</sup> 0,30  m 0,90	<p><b>Fodera di ricambio</b>            SpareCover            Housse deréchange            Ersatzbezug            Funda</p>

Composizione - Composition - Composition - Gruppe - Composición C1

**E208 dx** Laterale medio  
Lateral medium right

**E215 sx** Penisola cm 190  
Peninsula cm 190 left

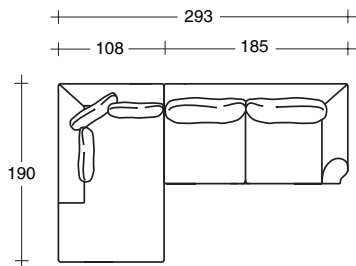

Composizione - Composition - Composition - Gruppe - Composición C2

**E208 dx** Laterale medio  
Lateral medium right

**E217 sx** Penisola cm 210  
Peninsula cm 210 left

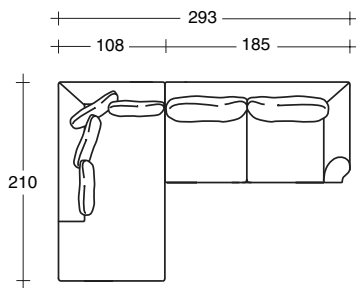

Composizione - Composition - Composition - Gruppe - Composición C3

**E210 dx** Laterale 2 posti  
Lateral 2 seaters right

**E 217 sx** Penisola cm 210  
Peninsula cm 210 left

