

bastian

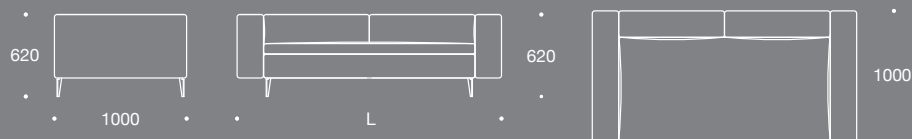

Dimensioni

Dimensions - Masse - Dimension - Tamaño



Piedini

Metallo finitura in titanio

Legs - Metal feet, finishing in titanium

Fuesse - Pieds en acier finition en titan

Pieds - Füße in Metall, Ausführung in Titanium

Pies - Patas en metal, acabado en titanio



Di serie

Standard - Standard

Standard - Estándar

Cuciture optional

Sewings - Naehnte - Coutures - Costuras



Filo cucitura contrasto (tessuto-pelle)

Sewing thread in contrasting color (fabric-leather) - Fil couture contrastant (tissu et cuir)
Naht in Kontrastfarbe (Stoff-Leder) - Costura con color de contraste



Chiusa

Closed
Feste Naht
Couture fermée
Costura cerrada

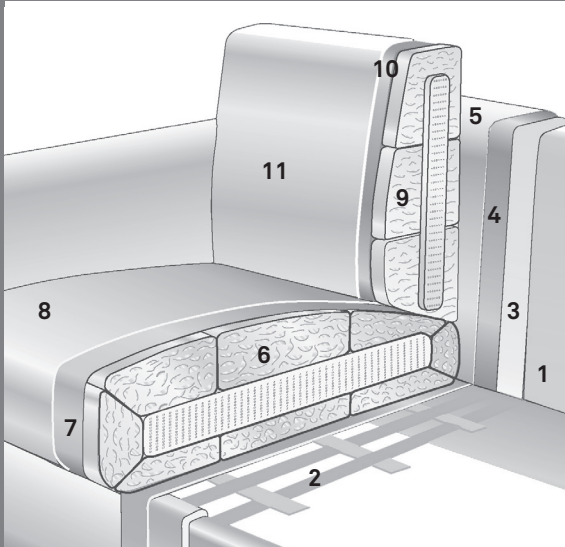

Struttura

Structure - Struktur
Structure - Estructura

1. Fusto legno

Wood structure - Structure en bois
Holzstruktur - Estructura de madera

2. Cinghia elastica

Belts - Elastische Gurte
Sangles élastiques - Correas elásticas

3. Gomma

Foam - Poliurethanschaum
Mousse - Poliuretano

4. Rivestimento

Cover - Bezug - Housse
Revestimiento

5. Tessuto

Fabric - Stoff - Tissu - Tela

Cuscino seduta

Seat cushion - Sitzkissen
Coussin de siège - Cojín del asiento

6. Gomma performance a bassa deformazione

Low deformation polyurethane foam performance - Mousse performance a déformation faible - Polyurethanschaum mit niedriger Deformationsquote - Rendimiento de la goma a baja deformación

7. Resinato

Resinate - Harzschaum
Resine mousse - Resina de goma

8. Tessuto

Fabric - Stoff - Tissu - Tela

Cuscino schienale

Back cushion - Rueckenkissen
Coussins de dossier - Cojines de respaldo

9. Misto piuma sterilizzata e siliconata

Sterilized and siliconized feather Mix
Stérilisés et siliconés mix des plumes
Sterilisierte und mit Silikon behandelte Federmischung - Mix de pluma esterilizada y silicona

10. Resinato

Resinate - Harzschaum
Resine mousse - Resina de goma

11. Tessuto

Fabric - Stoff - Tissu - Tela

Meccanismo bracciolo e/o schienale



















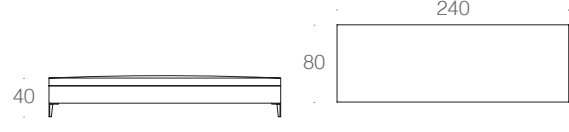



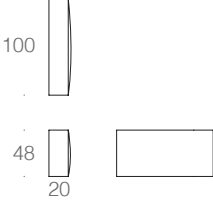



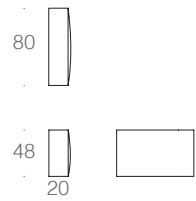



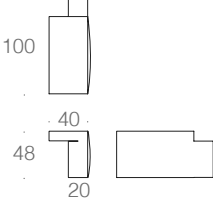

Mechanism armrest and/or backrest - Mécanisme de accouider et / ou dossier - Ruecken- und/oder Armlehn Mechanismus
Mecanismo del respaldo y / o apoyabrazos

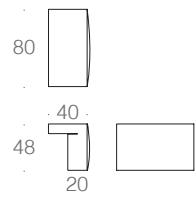















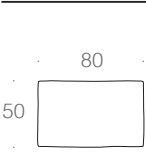



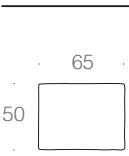

Vedi colori a catalogo

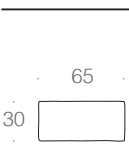
See colors in the catalogue - Siehe Farben im Katalog - Voir les couleurs dans le catalogue - Ver el color en el catálogo

bastian

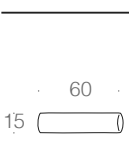
	<p>G001 Base cm. 80 Structure cm 80 Structure cm 80 Struktur cm 80 Estructura cm 80</p>	 kg  m ³ 0,25  m2,60	<p>Fodera di ricambio SpareCover Housse deréchange Ersatzbezug Funda</p>
	<p>G002 Base cm. 160 Structure cm 160 Structure cm 160 Struktur cm 160 Estructura cm 160</p>	 kg  m ³ 0,52  m3,70	<p>Fodera di ricambio SpareCover Housse deréchange Ersatzbezug Funda</p>
	<p>G003 Base cm. 240 Structure cm 240 Structure cm 240 Struktur cm 240 Estructura cm 240</p>	 kg  m ³ 0,77  m4,50	<p>Fodera di ricambio SpareCover Housse deréchange Ersatzbezug Funda</p>
	<p>G004 Bracciolo fisso cm. 100 Fixed armrest cm 100 Accoudoir fixed cm 100 Feste Armlehne cm 100 Brazo fijo cm 100</p>	 kg  m ³ 0,10  m1,40	<p>Fodera di ricambio SpareCover Housse deréchange Ersatzbezug Funda</p>
	<p>G005 Bracciolo/schiena- fisso cm. 80 Fixed arm-backrest cm 80 Accoudoir-dossier fixed cm 80 Feste Arm-Rückenlehne cm 80 Brazo y respaldo fijo cm 80</p>	 kg  m ³ 0,10  m1,20	<p>Fodera di ricambio SpareCover Housse deréchange Ersatzbezug Funda</p>
	<p>G006 Bracciolo movimento cm. 100 Moving armrest cm 100 Accoudoir à mouvement cm 100 Armlehn mit Funktion cm 100 Brazo con movimiento cm 100</p>	 kg  m ³ 0,20  m2,30	<p>Fodera di ricambio SpareCover Housse deréchange Ersatzbezug Funda</p>
	<p>G007 Bracciolo/sch. movi- mento cm. 80 Moving arm-backrest cm 80 Accoudoir-dossier à mouvement cm 80 Arm-Rückenlehne mit Funktion cm 80 Brazo y respaldo con movimiento cm 80</p>	 kg  m ³ 0,20  m2,10	<p>Fodera di ricambio SpareCover Housse deréchange Ersatzbezug Funda</p>
	<p>G008 Pouf cm. 100 x 100 Pouf cm 100x100 Pouf cm 100x100 Hocker cm 100x100 Pouf cm 100x100</p>	 kg  m ³ 0,40  m2,60	<p>Fodera di ricambio SpareCover Housse deréchange Ersatzbezug Funda</p>

bastian

	<p>G009 Pouf cm. 80 x 100 Pouf cm 80x100 Pouf cm 80x100 Hocker cm 80x100 Pouf cm 80x100</p>	 kg	 m ³ 0,33	 m 2,60 Fodera di ricambio SpareCover Housse deréchange Ersatzbezug Funda
	<p>M035 Cuscino schienale 80 x 50 Back cushion 80x50 Coussin dossier 80x50 Rückenkissen 80x50 Cojín respaldo 80x50</p>	 kg	 m ³ 0,40	 m 0,90 Fodera di ricambio SpareCover Housse deréchange Ersatzbezug Funda
	<p>M036 Cuscino schienale 65 x 50 Back cushion 65x50 Coussin dossier 65x50 Rückenkissen 65x50 Cojín respaldo 65x50</p>	 kg	 m ³ 0,33	 m 0,75 Fodera di ricambio SpareCover Housse deréchange Ersatzbezug Funda
	<p>M037 Poggiareni 65 x 30 Lumbar cushion 65x50 Coussin appui-reins 65x50 Nierenkissen 65x50 Cojín de apoyo renal 65x50</p>	 kg	 m ³ 0,20	 m 0,70 Fodera di ricambio SpareCover Housse deréchange Ersatzbezug Funda
	<p>M038 Rullo diametro 15 x 60 Roller cushion 15x60 Coussin a ruoleau 15x60 Rollkissen 15x60 Cojín a rodillo 15x60</p>	 kg	 m ³ 0,15	 m 0,35 Fodera di ricambio SpareCover Housse deréchange Ersatzbezug Funda

bastian

Composizione - Composition - Composition - Gruppe - Composición 1

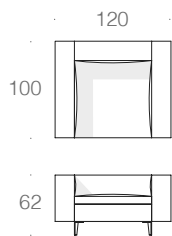

- 1-G001** Base cm. 80
Structure cm 80
- 2-G004** Bracciolo fisso cm. 100
Fixed armrest cm 100
- 1-G005** Bracciolo/schienale fisso cm. 80
Fixed arm-backrest cm 80

Composizione - Composition - Composition - Gruppe - Composición 2

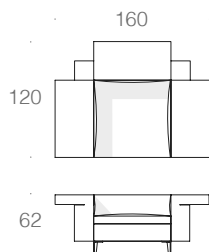

- 1-G001** Base cm. 80
Structure cm 80
- 2-G006** Bracciolo movimento cm. 100
Moving armrest cm 100
- 1-G007** Bracciolo/sch. movimento cm. 80
Moving arm-backrest cm 80

Composizione - Composition - Composition - Gruppe - Composición 3

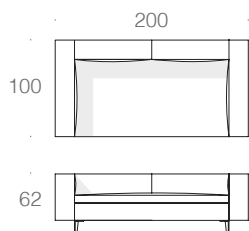

- 1-G002** Base cm. 160
Structure cm 160
- 2-G004** Bracciolo fisso cm. 100
Fixed armrest cm 100
- 2-G005** Bracciolo/schienale fisso cm. 80
Fixed arm-backrest cm 80

Composizione - Composition - Composition - Gruppe - Composición 4

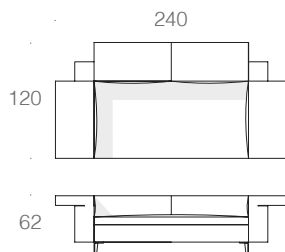

- 1-G002** Base cm. 160
Structure cm 160
- 2-G006** Bracciolo movimento cm. 100
Moving armrest cm 100
- 2-G007** Bracciolo/sch. movimento cm. 80
Moving arm-backrest cm 80

bastian

Composizione - Composition - Composition - Gruppe - Composición 5

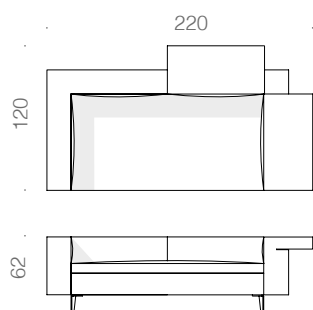

- 1-G002** Base cm. 160
Structure cm 160
- 1-G004** Bracciolo fisso cm. 100
Fixed armrest cm 100
- 1-G006** Bracciolo movimento cm. 100
Moving armrest cm 100
- 1-G005** Bracciolo/schienale fisso cm. 80
Fixed arm-backrest cm 80
- 1-G007** Bracciolo/sch. movimento cm. 80
Moving arm-backrest cm 80

Composizione - Composition - Composition - Gruppe - Composición 6

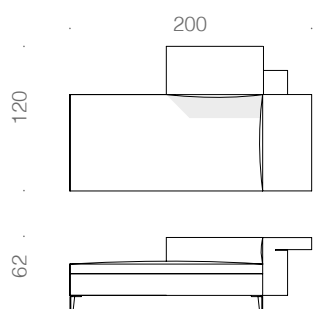

- 1-G002** Base cm. 160
Structure cm 160
- 1-G006** Bracciolo movimento cm. 100
Moving armrest cm 100
- 1-G007** Bracciolo/sch. movimento cm. 80
Moving arm-backrest cm 80

Composizione - Composition - Composition - Gruppe - Composición 7

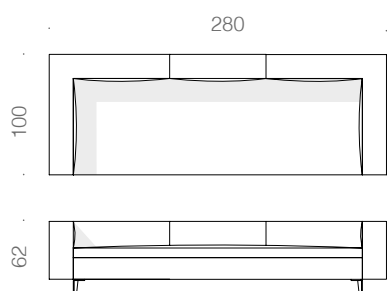

- 1-G003** Base cm. 240
Structure cm 240
- 2-G004** Bracciolo fisso cm. 100
Fixed armrest cm 100
- 3-G005** Bracciolo/schienale fisso cm. 80
Fixed arm-backrest cm 80

Composizione - Composition - Composition - Gruppe - Composición 8

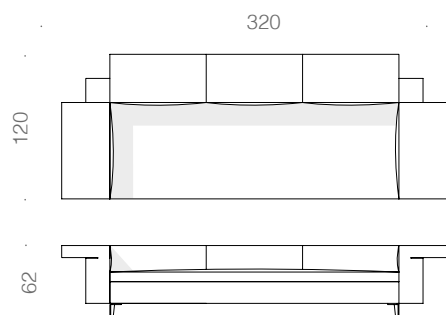

- 1-G003** Base cm. 240
Structure cm 240
- 2-G006** Bracciolo movimento cm. 100
Moving armrest cm 100
- 3-G007** Bracciolo/sch. movimento cm. 80
Moving arm-backrest cm 80

bastian

Composizione - Composition - Composition - Gruppe - Composición 9

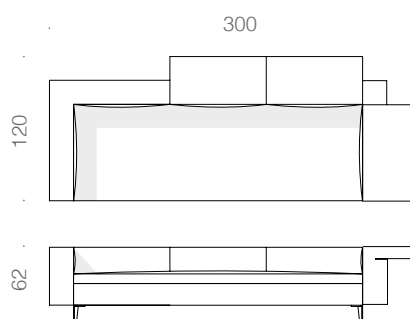

- 1-G003** Base cm. 240
Structure cm 240
- 1-G004** Bracciolo fisso cm. 100
Fixed armrest cm 100
- 1-G006** Bracciolo movimento cm. 100
Moving armrest cm 100
- 1-G005** Bracciolo/schienale fisso cm. 80
Fixed arm-backrest cm 80
- 2-G007** Bracciolo/sch. movimento cm. 80
Moving arm-backrest cm 80

Composizione - Composition - Composition - Gruppe - Composición 10

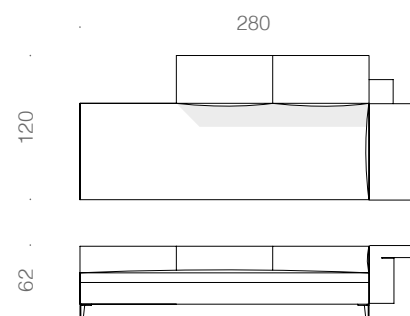

- 1-G003** Base cm. 240
Structure cm 240
- 1-G006** Bracciolo movimento cm. 100
Moving armrest cm 100
- 2-G007** Bracciolo/sch. movimento cm. 80
Moving arm-backrest cm 80

Composizione - Composition - Composition - Gruppe - Composición 11

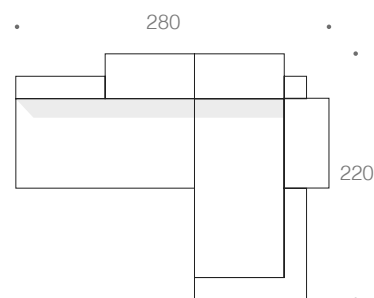

- 2-G002** Base cm. 160
Structure cm 160
- 2-G005** Bracciolo/schienale fisso cm. 80
Fixed arm-backrest cm 80
- 1-G004** Bracciolo fisso cm. 100
Fixed armrest cm 100
- 2-G007** Bracciolo/sch. movimento cm. 80
Moving arm-backrest cm 80
- 1-G006** Bracciolo movimento cm. 100
Moving armrest cm 100

Composizione - Composition - Composition - Gruppe - Composición 12

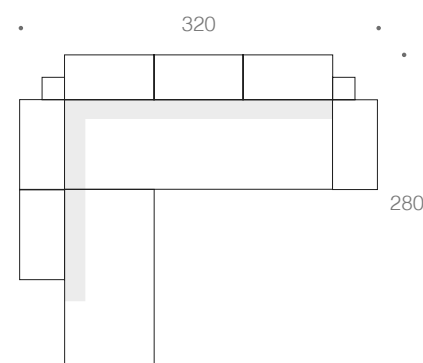

- 1-G002** Base cm. 160
Structure cm 160
- 1-G003** Base cm. 240
Structure cm 240
- 4-G007** Bracciolo/sch. movimento cm. 80
Moving arm-backrest cm 80
- 2-G006** Bracciolo movimento cm. 100
Moving armrest cm 100

bastian

Composizione - Composition - Composition - Gruppe - Composición 13

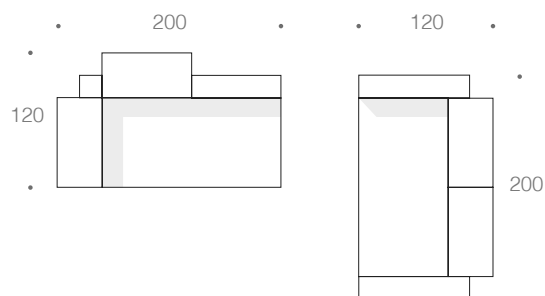

- 2-G002** Base cm. 160
Structure cm 160
- 3-G007** Bracciolo/sch. movimento cm. 80
Moving arm-backrest cm 80
- 1-G006** Bracciolo movimento cm. 100
Moving armrest cm 100
- 1-G005** Bracciolo/schienale fisso cm. 80
Fixed arm-backrest cm 80
- 2-G004** Bracciolo fisso cm. 100
Fixed armrest cm 100

Composizione - Composition - Composition - Gruppe - Composición 15

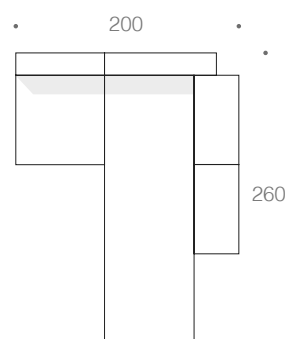

- 1-G003** Base cm. 240
Structure cm 240
- 1-G001** Base cm. 80
Structure cm 80
- 1-G005** Bracciolo/schienale fisso cm. 80
Fixed arm-backrest cm 80
- 1-G004** Bracciolo fisso cm. 100
Fixed armrest cm 100
- 2-G007** Bracciolo/sch. movimento cm. 80
Moving arm-backrest cm 80

Composizione - Composition - Composition - Gruppe - Composición 16

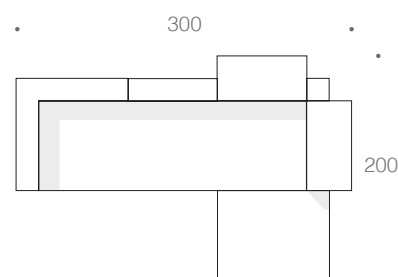

- 1-G003** Base cm. 240
Structure cm 240
- 1-G004** Bracciolo fisso cm. 100
Fixed armrest cm 100
- 1-G006** Bracciolo movimento cm. 100
Moving armrest cm 100
- 2-G005** Bracciolo/schienale fisso cm. 80
Fixed arm-backrest cm 80
- 3-G007** Bracciolo/sch. movimento cm. 80
Moving arm-backrest cm 80

1-G009 Pouf cm. 80 x 100
Pouf cm 80x100

Composizione - Composition - Composition - Gruppe - Composición 17

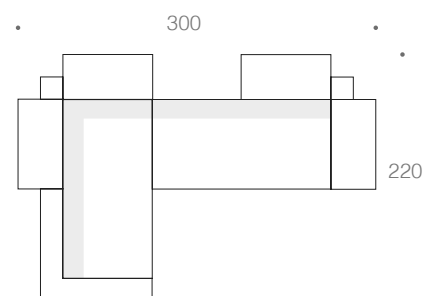

- 2-G002** Base cm. 160
Structure cm 160
- 2-G006** Bracciolo movimento cm. 100
Moving armrest cm 100
- 1-G004** Bracciolo fisso cm. 100
Fixed armrest cm 100
- 1-G005** Bracciolo/schienale fisso cm. 80
Fixed arm-backrest cm 80
- 2-G007** Bracciolo/sch. movimento cm. 80
Moving arm-backrest cm 80

bastian

Composizione - Composition - Composition - Gruppe - Composición 18

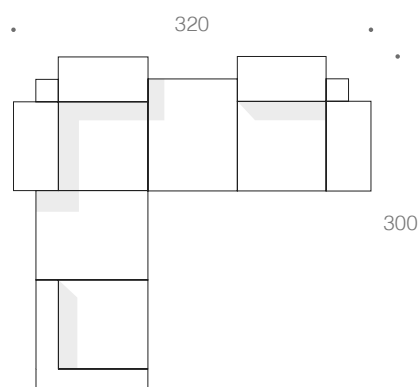

- 1-G003** Base cm. 240
Structure cm 240
- 1-G001** Base cm. 80
Structure cm 80
- 1-G009** Pouf cm. 80 x 100
Pouf cm 80x100
- 2-G006** Bracciolo movimento cm. 100
Moving armrest cm 100
- 1-G004** Bracciolo fisso cm. 100
Fixed armrest cm 100

- 1-G005** Bracciolo/schienale fisso cm. 80
Fixed arm-backrest cm 80
- 2-G007** Bracciolo/sch. movimento cm. 80
Moving arm-backrest cm 80

Composizione - Composition - Composition - Gruppe - Composición 19

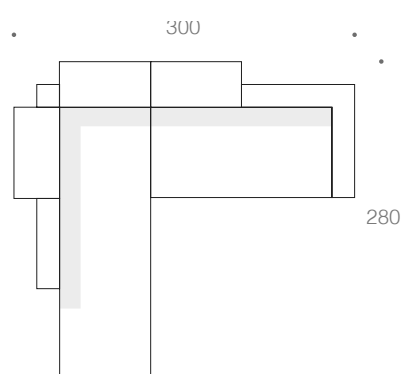

- 1-G003** Base cm. 240
Structure cm 240
- 1-G002** Base cm. 160
Structure cm 160
- 1-G006** Bracciolo movimento cm. 100
Moving armrest cm 100
- 1-G004** Bracciolo fisso cm. 100
Fixed armrest cm 100
- 2-G005** Bracciolo/schienale fisso cm. 80
Fixed arm-backrest cm 80

- 2-G007** Bracciolo/sch. movimento cm. 80
Moving arm-backrest cm 80

Composizione - Composition - Composition - Gruppe - Composición 20

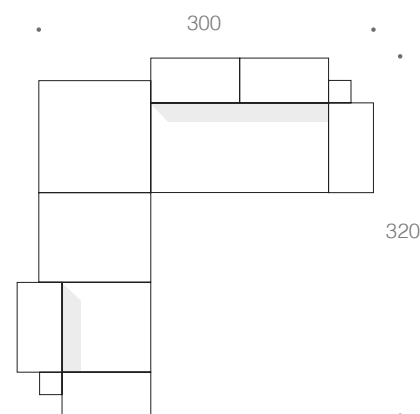

- 1-G002** Base cm. 160
Structure cm 160
- 1-G001** Base cm. 80
Structure cm 80
- 1-G008** Pouf cm. 100 x 100
Pouf cm 100x100
- 1-G009** Pouf cm. 80 x 100
Pouf cm 80x100
- 2-G006** Bracciolo movimento cm. 100
Moving armrest cm 100

- 3-G007** Bracciolo/sch. movimento cm. 80
Moving arm-backrest cm 80