

# ernest



## Dimensioni

Dimensions - Masse - Dimension - Tamaño



## Piedini

Metallo finitura in nichel-nero

**Legs** - Metal finished in black nickel

**Fuesse** - Métal finition nickel noir

**Pieds** - Metall Ausführung Nickel schwarz

**Pies** - Metal con acabado de níquel negro



## Di serie

Standard - Standard

Standard - Estándar

## Cuciture optional

Sewings - Naehnte - Coutures - Costuras



### Bordo canneté colorato

Piping with colored gross grain - Passepoil avec gross grain coloré - Keder mit buntem Gross Grain - canneté coloreado

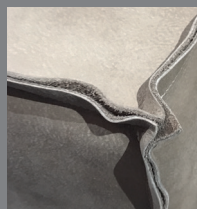

### Bordo al vivo (pelle)

Open cut sewing (leather) - Couture ouverte (cuir) - Offenkantige Naht (Leder) - Costuras abiertas (cuero)



### Taglio vivo con cucitura rovesciata (pelle)

Open cut inverted sewing (leather) - Couture ouverte invertie (cuir) - Offenkantige umgekehrte Naht (Leder) - Costuras abiertas volcadas (cuero)



### Filo cucitura contrasto (tessuto-pelle)

Sewing thread in contrasting color (fabric-leather) - Fil couture contrastant (tissu et cuir) - Naht in Kontrastfarbe (Stoff-Leder) - Costura con color de contraste



### Chiusa

Closed Feste Naht Couture fermée Costura cerrada

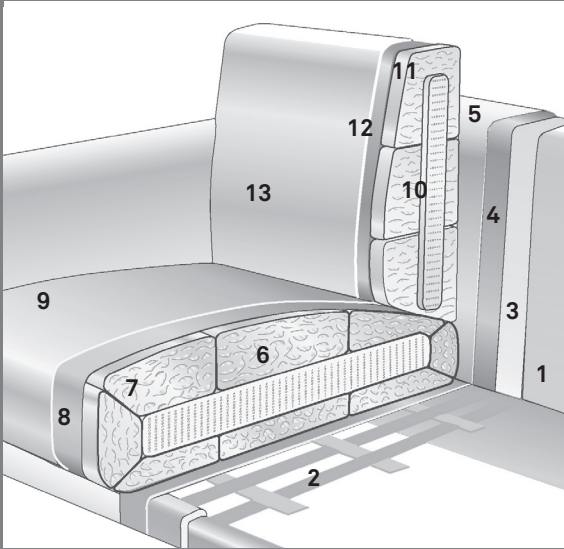

## Struttura

Structure - Struktur  
Structure - Estructura

### 1. Fusto legno

Wood structure - Structure en bois  
Holzstruktur - Estructura de madera

### 2. Cinghia elastica

Belts - Elastische Gurte  
Sangles élastiques - Correas elásticas

### 3. Gomma

Foam - Poliurethanschaum  
Mousse - Poliuretano

### 4. Rivestimento

Cover - Bezug - Housse  
Revestimiento

### 5. Tessuto

Fabric - Stoff - Tissu - Tela

## Cuscino seduta

Seat cushion - Sitzkissen  
Coussin de siège - Cojín del asiento

### 6. Gomma performance a bassa deformazione

Low deformation polyurethane foam performance - Mousse performance a déformation faible - Polyurethanschaum mit niedriger Deformationsquote - Rendimiento de la goma a baja deformación

### 7. A richiesta piuma poliuretano espanso performance a bassa deformazione più materassino misto piuma a scomparti

Polyurethane foam with low deformation performance, and mat of feather mix divided into sectionals - Polyuréthane avec une faible déformation performance, et mat du mélange de plumes divisé en sections - Polyurethanschaum mit niedriger Deformation Performance, und Federmischungsmatte in Kassetten unterteilt - La espuma de poliuretano con rendimiento a baja deformación, más de mezcla de pluma con compartimentos

### 8. Resinato

Resinate - Harzschaum  
Resine mousse - Resina de goma

### 9. Tessuto

Fabric - Stoff - Tissu - Tela

## Cuscino schienale

Back cushion - Rueckenkissen  
Coussins de dossier - Cojines de respaldo

### 10. Misto piuma sterilizzata e siliconata

Sterilized and siliconized feather Mix  
Stérilisés et siliconés mix des plumes  
Sterilisierte und mit Silikon behandelte Federmischung - Mix de pluma esterilizada y silicona

### 11. Gomma

Foam - Poliurethanschaum  
Mousse - Poliuretano











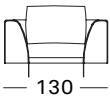



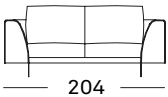



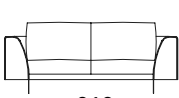



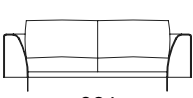



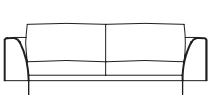



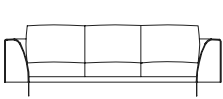

### 12. Resinato

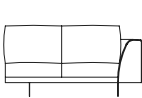
Resinate - Harzschaum  
Resine mousse - Resina de goma



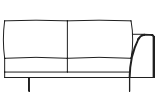







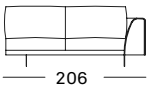











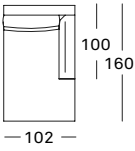



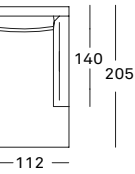



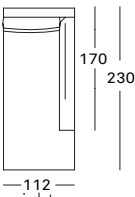

### 13. Tessuto

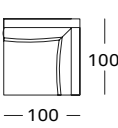
Fabric - Stoff - Tissu - Tela

# ernest

 <p>130</p>	<p><b>D906 Poltrona cm. 130</b>            Armchair cm 130            Fauteuil cm 130            Sessel cm 130            Butaca cm 130</p>	 kg  m <sup>3</sup> 1  m 7	<p><b>Fodera di ricambio</b>            SpareCover            Housse deréchange            Ersatzbezug            Funda</p>
 <p>204</p>	<p><b>D905 Divano cm. 204</b>            Sofà cm 204            Canapè cm 204            Sofa cm 204            Sofà cm 204</p>	 kg  m <sup>3</sup> 1,65  m 9,70	<p><b>Fodera di ricambio</b>            SpareCover            Housse deréchange            Ersatzbezug            Funda</p>
 <p>219</p>	<p><b>D904 Divano cm. 219</b>            Sofà cm 219            Canapè cm 219            Sofa cm 219            Sofà cm 219</p>	 kg  m <sup>3</sup> 1,80  m 10,40	<p><b>Fodera di ricambio</b>            SpareCover            Housse deréchange            Ersatzbezug            Funda</p>
 <p>234</p>	<p><b>D903 Divano cm. 234</b>            Sofà cm 234            Canapè cm 234            Sofa cm 234            Sofà cm 234</p>	 kg  m <sup>3</sup> 1,90  m 10,50	<p><b>Fodera di ricambio</b>            SpareCover            Housse deréchange            Ersatzbezug            Funda</p>
 <p>249</p>	<p><b>D902 Divano cm. 249</b>            Sofà cm 249            Canapè cm 249            Sofa cm 249            Sofà cm 249</p>	 kg  m <sup>3</sup> 2  m 10,60	<p><b>Fodera di ricambio</b>            SpareCover            Housse deréchange            Ersatzbezug            Funda</p>
 <p>279</p>	<p><b>D901 Divano cm. 279</b>            Sofà cm 279            Canapè cm 279            Sofa cm 279            Sofà cm 279</p>	 kg  m <sup>3</sup> 2,30  m 13,50	<p><b>Fodera di ricambio</b>            SpareCover            Housse deréchange            Ersatzbezug            Funda</p>
 <p>176</p> <p>dx-right</p>	<p><b>D916 Laterale cm. 176</b>            Lateral cm 176            Laterale cm 176            Seitenelement cm 176</p> <p><b>D915</b>            Lateral cm 176</p> <p>dx-right</p>	 kg  m <sup>3</sup> 1,45  m 8,60	<p><b>Fodera di ricambio</b>            SpareCover            Housse deréchange            Ersatzbezug            Funda</p>
 <p>191</p> <p>dx-right</p>	<p><b>D914 Laterale cm. 191</b>            Lateral cm 191            Laterale cm 191            Seitenelement cm 191</p> <p><b>D913</b>            Lateral cm 191</p> <p>dx-right</p>	 kg  m <sup>3</sup> 1,55  m 9,30	<p><b>Fodera di ricambio</b>            SpareCover            Housse deréchange            Ersatzbezug            Funda</p>

# ernest

 <p>206</p> <p>dx-right</p>	<p><b>D912</b> Laterale cm. 206 sx-left Laterale cm 206 Seitenelement cm 206</p> <p><b>D911</b> Laterale cm 206 dx-right</p>	 kg  m <sup>3</sup> 1,70  m 9,40	<p><b>Fodera di ricambio</b> SpareCover Housse deréchange Ersatzbezug Funda</p>
 <p>221</p> <p>dx-right</p>	<p><b>D910</b> Laterale cm. 221 sx-left Laterale cm 221 Seitenelement cm 221</p> <p><b>D909</b> Laterale cm 221 dx-right</p>	 kg  m <sup>3</sup> 1,81  m 9,50	<p><b>Fodera di ricambio</b> SpareCover Housse deréchange Ersatzbezug Funda</p>
 <p>251</p> <p>dx-right</p>	<p><b>D908</b> Laterale cm. 251 sx-left Laterale cm 251 Seitenelement cm 251</p> <p><b>D907</b> Laterale cm 251 dx-right</p>	 kg  m <sup>3</sup> 2  m 12,50	<p><b>Fodera di ricambio</b> SpareCover Housse deréchange Ersatzbezug Funda</p>
 <p>100 160 102</p> <p>dx-right</p>	<p><b>D922</b> Chaise Longue cm. 160 sx-left Chaise longue cm 160 Chaise longue cm 160</p> <p><b>D921</b> Chaise longue cm 160 dx-right</p>	 kg  m <sup>3</sup> 1,40  m 7	<p><b>Fodera di ricambio</b> SpareCover Housse deréchange Ersatzbezug Funda</p>
 <p>140 205 112</p> <p>dx-right</p>	<p><b>D920</b> Chaise Longue cm. 205 sx-left Chaise longue cm 205 Chaise longue cm 205</p> <p><b>D919</b> Chaise longue cm 205 dx-right</p>	 kg  m <sup>3</sup> 1,88  m 8	<p><b>Fodera di ricambio</b> SpareCover Housse deréchange Ersatzbezug Funda</p>
 <p>170 230 112</p> <p>dx-right</p>	<p><b>D918</b> Chaise Longue cm. 230 sx-left Chaise longue cm 230 Chaise longue cm 230</p> <p><b>D917</b> Chaise longue cm 230 dx-right</p>	 kg  m <sup>3</sup> 2,11  m 10	<p><b>Fodera di ricambio</b> SpareCover Housse deréchange Ersatzbezug Funda</p>
 <p>100 100</p>	<p><b>D923</b> Angolo quadro cm. 100 Corner cm 100 Angle cm 100 Ecke cm 100 Esquina cm 100</p>	 kg  m <sup>3</sup> 0,82  m 7	<p><b>Fodera di ricambio</b> SpareCover Housse deréchange Ersatzbezug Funda</p>
 <p>96</p> 	<p><b>D924</b> Centrale cm. 96 Central element cm 96 Centrale cm 96 Mittel Element cm 96 Elemento central cm 96</p>	 kg  m <sup>3</sup> 0,78  m 0,45	<p><b>Fodera di ricambio</b> SpareCover Housse deréchange Ersatzbezug Funda</p>

# ernest

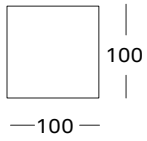

**D925 Pouf cm. 100 x 100**  
 Pouf cm 100 x 100  
 Pouf cm 100 x 100  
 Hocker cm 100 x 100  
 Pouf cm 100 x 100



kg



m<sup>3</sup> 0,42



m<sup>3</sup> 3,50

**Fodera di ricambio**  
 SpareCover  
 Housse deréchange  
 Ersatzbezug  
 Funda

## Composizione - Composition - Composition - Gruppe - Composición C1

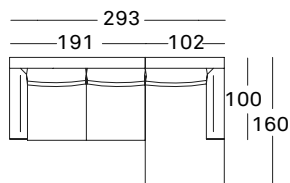

**D914 sx** Laterale cm. 191  
Lateral cm 191

**D921 sx** Chaise Longue cm. 160  
Chaise longue cm 160

## Composizione - Composition - Composition - Gruppe - Composición C2

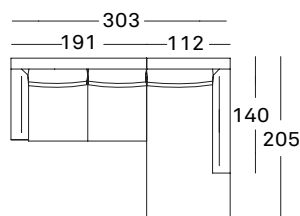

**D914 sx** Laterale cm. 191  
Lateral cm 191

**D919 dx** Chaise Longue cm. 205  
Chaise longue cm 205

## Composizione - Composition - Composition - Gruppe - Composición C3

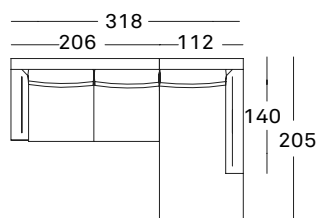

**D912 sx** Laterale cm. 206  
Lateral cm 206

**D919 dx** Chaise Longue cm. 205  
Chaise longue cm 205

## Composizione - Composition - Composition - Gruppe - Composición C4

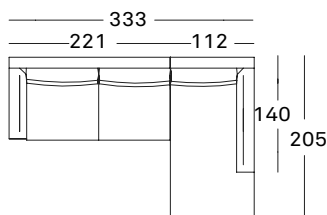

**D910 sx** Laterale cm. 221  
Lateral cm 221





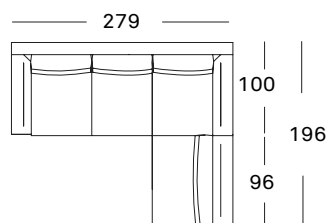





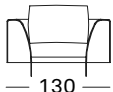







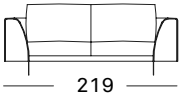



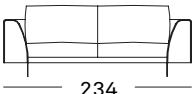







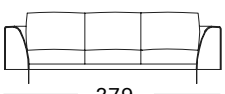

**D919 dx** Chaise Longue cm. 205  
Chaise longue cm 205

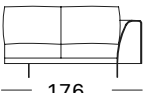
Composizione - Composition - Composition - Gruppe - Composición C5



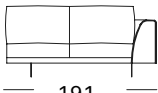









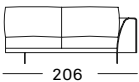



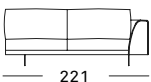



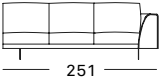



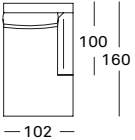



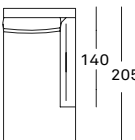



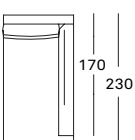

- D901** **Divano cm. 279**  
Sofà cm 279
- D924** **Centrale cm. 96**  
Central element cm 96

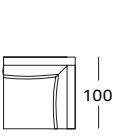
# ernest piuma

 <p>130</p>	<p><b>E906 Poltrona cm. 130</b>            Armchair cm 130            Fauteuil cm 130            Sessel cm 130            Butaca cm 130</p>	 kg  m <sup>3</sup> 1  m 7	<p><b>Fodera di ricambio</b>            SpareCover            Housse deréchange            Ersatzbezug            Funda</p>
 <p>204</p>	<p><b>E905 Divano cm. 204</b>            Sofà cm 204            Canapè cm 204            Sofa cm 204            Sofà cm 204</p>	 kg  m <sup>3</sup> 1,65  m 9,70	<p><b>Fodera di ricambio</b>            SpareCover            Housse deréchange            Ersatzbezug            Funda</p>
 <p>219</p>	<p><b>E904 Divano cm. 219</b>            Sofà cm 219            Canapè cm 219            Sofa cm 219            Sofà cm 219</p>	 kg  m <sup>3</sup> 1,80  m 10,40	<p><b>Fodera di ricambio</b>            SpareCover            Housse deréchange            Ersatzbezug            Funda</p>
 <p>234</p>	<p><b>E903 Divano cm. 234</b>            Sofà cm 234            Canapè cm 234            Sofa cm 234            Sofà cm 234</p>	 kg  m <sup>3</sup> 1,90  m 10,50	<p><b>Fodera di ricambio</b>            SpareCover            Housse deréchange            Ersatzbezug            Funda</p>
 <p>249</p>	<p><b>E902 Divano cm. 249</b>            Sofà cm 249            Canapè cm 249            Sofa cm 249            Sofà cm 249</p>	 kg  m <sup>3</sup> 2  m 10,60	<p><b>Fodera di ricambio</b>            SpareCover            Housse deréchange            Ersatzbezug            Funda</p>
 <p>279</p>	<p><b>E901 Divano cm. 279</b>            Sofà cm 279            Canapè cm 279            Sofa cm 279            Sofà cm 279</p>	 kg  m <sup>3</sup> 2,30  m 13,5	<p><b>Fodera di ricambio</b>            SpareCover            Housse deréchange            Ersatzbezug            Funda</p>
 <p>176</p> <p>dx-right</p>	<p><b>E916 Laterale cm. 176</b>            Lateral cm 176            Laterale cm 176            Seitenelement cm 176</p> <p><b>E915</b>            Lateral cm 176</p> <p>dx-right</p>	 kg  m <sup>3</sup> 1,45  m 8,60	<p><b>Fodera di ricambio</b>            SpareCover            Housse deréchange            Ersatzbezug            Funda</p>
 <p>191</p> <p>dx-right</p>	<p><b>E914 Laterale cm. 191</b>            Lateral cm 191            Laterale cm 191            Seitenelement cm 191</p> <p><b>E913</b>            Lateral cm 191</p> <p>dx-right</p>	 kg  m <sup>3</sup> 1,55  m 9,30	<p><b>Fodera di ricambio</b>            SpareCover            Housse deréchange            Ersatzbezug            Funda</p>

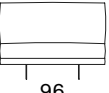
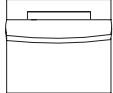

# ernest piuma

 <p>206</p> <p>dx-right</p>	<p><b>E912</b> Laterale cm. 206 Lateral cm 206 Laterale cm 206 Seitenelement cm 206</p> <p><b>E911</b> Lateral cm 206 dx-right</p>	 kg  m <sup>3</sup> 1,70  m 9,40	<p><b>Fodera di ricambio</b> SpareCover Housse deréchange Ersatzbezug Funda</p>
 <p>221</p> <p>dx-right</p>	<p><b>E910</b> Laterale cm. 221 Lateral cm 221 Laterale cm 221 Seitenelement cm 221</p> <p><b>E909</b> Lateral cm 221 dx-right</p>	 kg  m <sup>3</sup> 1,81  m 9,50	<p><b>Fodera di ricambio</b> SpareCover Housse deréchange Ersatzbezug Funda</p>
 <p>251</p> <p>dx-right</p>	<p><b>E908</b> Laterale cm. 251 Lateral cm 251 Laterale cm 251 Seitenelement cm 251</p> <p><b>E907</b> Lateral cm 251 dx-right</p>	 kg  m <sup>3</sup> 2  m 12,50	<p><b>Fodera di ricambio</b> SpareCover Housse deréchange Ersatzbezug Funda</p>
 <p>100 160</p> <p>— 102 —</p> <p>dx-right</p>	<p><b>E922</b> Chaise Longue cm. 160 Chaise longue cm 160 Chaise longue cm 160 Chaise longue cm 160</p> <p><b>E921</b> Chaise longue cm 160 dx-right</p>	 kg  m <sup>3</sup> 1,40  m 7	<p><b>Fodera di ricambio</b> SpareCover Housse deréchange Ersatzbezug Funda</p>
 <p>140 205</p> <p>— 112 —</p> <p>dx-right</p>	<p><b>E920</b> Chaise Longue cm. 205 Chaise longue cm 205 Chaise longue cm 205 Chaise longue cm 205</p> <p><b>E919</b> Chaise longue cm 205 dx-right</p>	 kg  m <sup>3</sup> 1,88  m 8	<p><b>Fodera di ricambio</b> SpareCover Housse deréchange Ersatzbezug Funda</p>
 <p>170 230</p> <p>— 112 —</p> <p>sx-left</p>	<p><b>E918</b> Chaise Longue cm. 230 Chaise longue cm 230 Chaise longue cm 230 Chaise longue cm 230</p> <p><b>E917</b> Chaise longue cm 230 dx-right</p>	 kg  m <sup>3</sup> 2,11  m 10	<p><b>Fodera di ricambio</b> SpareCover Housse deréchange Ersatzbezug Funda</p>
 <p>100</p> <p>— 100 —</p>	<p><b>E923</b> Angolo quadro cm. 100 Corner cm 100 Angle cm 100 Ecke cm 100 Esquina cm 100</p>	 kg  m <sup>3</sup> 0,82  m 7	<p><b>Fodera di ricambio</b> SpareCover Housse deréchange Ersatzbezug Funda</p>
 <p>96</p> 	<p><b>E924</b> Centrale cm. 96 Central element cm 96 Centrale cm 96 Mittel Element cm 96 Elemento central cm 96</p>	 kg  m <sup>3</sup> 0,78  m 4,50	<p><b>Fodera di ricambio</b> SpareCover Housse deréchange Ersatzbezug Funda</p>

# ernest piuma

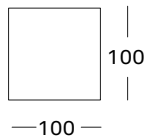

**E925 Pouf cm. 100 x 100**  
Pouf cm 100 x 100  
Pouf cm 100 x 100  
Hocker cm 100 x 100  
Pouf cm 100 x 100



kg



m<sup>3</sup> 0,42



m 3,50

**Fodera di ricambio**  
SpareCover  
Housse deréchange  
Ersatzbezug  
Funda

# ernest piuma

## Composizione - Composition - Composition - Gruppe - Composición C1

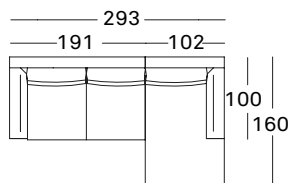

**E914 sx** Laterale cm. 191  
Lateral cm 191

**E921 dx** Chaise Longue cm. 160  
Chaise longue cm 160

## Composizione - Composition - Composition - Gruppe - Composición C2

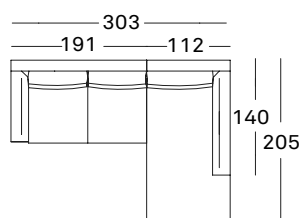

**E914 sx** Laterale cm. 191  
Lateral cm 191

**E919 dx** Chaise Longue cm. 205  
Chaise longue cm 205

## Composizione - Composition - Composition - Gruppe - Composición C3

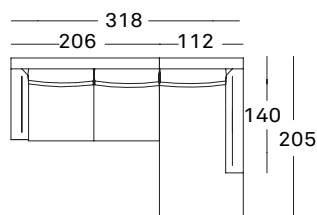

**E912 sx** Laterale cm. 206  
Lateral cm 206

**E919 dx** Chaise Longue cm. 205  
Chaise longue cm 205

## Composizione - Composition - Composition - Gruppe - Composición C4

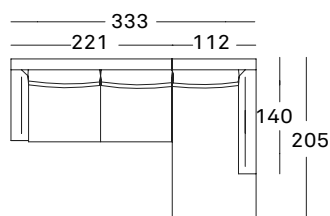

**E910 sx** Laterale cm. 221  
Lateral cm 221

**E919 dx** Chaise Longue cm. 205  
Chaise longue cm 205

# ernest piuma

Composizione - Composition - Composition - Gruppe - Composición C5

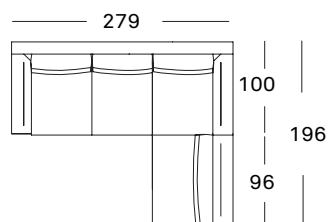

**E901**      **Divano cm. 279**  
Sofà cm 279

**E924**      **Centrale cm. 96**  
Central element cm 96