

flower



Dimensioni

Dimensions - Masse - Dimension - Tamaño



Piedini

Metallo finitura in nichel-nero

Legs - Metal finished in black nickel

Fuesse - Métal finition nickel noir

Pieds - Metall Ausführung Nickel schwarz

Pies - Metal con acabado de níquel negro



Di serie

Standard - Standard

Standard - Estándar

Cuciture optional

Sewings - Naehnte - Coutures - Costuras

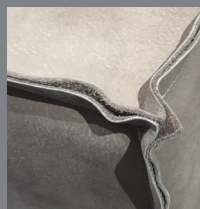

Bordo al vivo (pelle)

Open cut sewing (leather) - Couture ouverte (cuir) - Offenkantige Naht (Leder) - Costuras abiertas (cuero)



Filo cucitura contrasto (tessuto-pelle)

Sewing thread in contrasting color (fabric-leather) - Fil couture contrastant (tissu et cuir) - Naht in Kontrastfarbe (Stoff-Leder) - Costura con color de contraste



Chiusa

Closed Feste Naht Couture fermée Costura cerrada

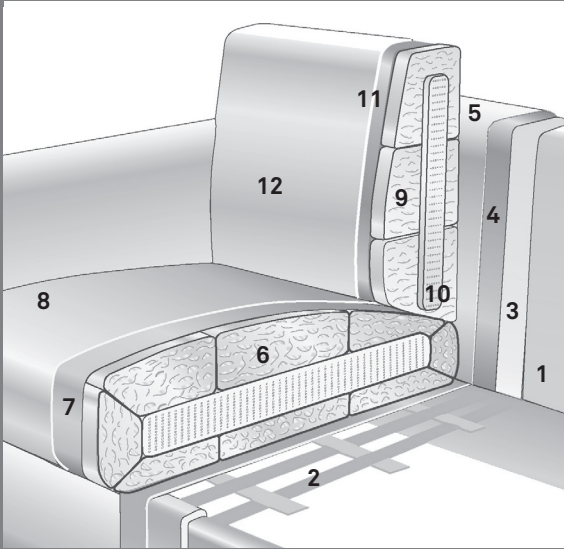

Struttura

Structure - Struktur
Structure - Estructura

1. Fusto legno

Wood structure - Structure en bois
Holzstruktur - Estructura de madera

2. Cinghia elastica

Belts - Elastische Gurte
Sangles élastiques - Correas elásticas

3. Gomma

Foam - Poliurethanschaum
Mousse - Poliuretano

4. Rivestimento

Cover - Bezug - Housse
Revestimiento

5. Tessuto

Fabric - Stoff - Tissu - Tela

Cuscino seduta

Seat cushion - Sitzkissen
Coussin de siège - Cojín del asiento

6. Gomma a quote differenziate a bassa deformazione

Differentiated thickness
polyurethane foam - Mousse
de Polyuréthane avec densités
différentes - Polyurethanschaum
mit unterschiedlicher Dichte - Goma
en Polyurethan con diferentes
densidades

7. Resinato

Resinate - Harzschaum
Resine mousse - Resina de goma

8. Tessuto

Fabric - Stoff - Tissu - Tela

Cuscino schienale

Back cushion - Rueckenkissen
Coussins de dossier - Cojines de respaldo

9. Struttura in legno appesantita con sabbia e rivestita da falda acrilica

Structure in wood weighted with
sand and covered by an acrylic linen
- Cadre en bois lesté de sable et
recouvert d'ouate en feuille acrylique
- Struktur in Holz, mit Sand belastet
und mit einer Acrylmatte ueberzogen
- Estructura de madera cargada con
arena e revestida de una capa acrílica

10. Antidrucciolo con silicone nella base della schiena

Non-slip with silicon on the base
of the backrest - Antidérapant
avec silicone dans la base du dos -
Rutschfest mit Silikon an der Basis
der Rückenlehne - Antideslizante con
silicona en la base de la espalda

11. Resinato

Resinate - Harzschaum
Resine mousse - Resina de goma

12. Tessuto

Fabric - Stoff - Tissu - Tela

flowers

	<p>F604 Base cm 100 Ottoman cm 100 Base cm 100 Base cm 100 Basis cm 100</p>	kg m ³ 0,42 m 2,50	<p>Fodera di ricambio SpareCover Housse deréchange Ersatzbezug Funda</p>
	<p>F603 Base cm 160 Ottoman cm 160 Base cm 160 Base cm 160 Basis cm 160</p>	kg m ³ 0,67 m 3,50	<p>Fodera di ricambio SpareCover Housse deréchange Ersatzbezug Funda</p>
	<p>F602 Base cm 180 Ottoman cm 180 Base cm 180 Base cm 180 Basis cm 180</p>	kg m ³ 0,75 m 4,00	<p>Fodera di ricambio SpareCover Housse deréchange Ersatzbezug Funda</p>
	<p>F601 Base cm 200 Ottoman cm 200 Base cm 200 Base cm 200 Basis cm 200</p>	kg m ³ 0,84 m 4,50	<p>Fodera di ricambio SpareCover Housse deréchange Ersatzbezug Funda</p>
	<p>F611 Isola cm 112 Isle cm 112 île cm 112 Isla cm 112 Insel cm 112</p>	kg m ³ 0,47 m 2,50	<p>Fodera di ricambio SpareCover Housse deréchange Ersatzbezug Funda</p>
<p>sx-left</p>	<p>F612 dx-right</p>		
	<p>F609 Isola cm 205 Isle cm.205 île cm 205 Isla cm 205 Insel cm 205</p>	kg 0 m ³ 0,86 m 4,50	<p>Fodera di ricambio SpareCover Housse deréchange Ersatzbezug Funda</p>
<p>sx-left</p>	<p>F610 dx-right</p>		
	<p>F607 Isola cm 225 Isle cm 225 île cm 225 Isla cm 225 Insel cm 225</p>	kg m ³ 0,95 m 5,00	<p>Fodera di ricambio SpareCover Housse deréchange Ersatzbezug Funda</p>
<p>sx-left</p>	<p>F608 dx-right</p>		
	<p>F605 Isola cm 245 Isle cm 245 île cm 245 Isla cm 245 Insel cm 245</p>	kg m ³ 1,05 m 5,50	<p>Fodera di ricambio SpareCover Housse deréchange Ersatzbezug Funda</p>
<p>sx-left</p>	<p>F606 dx-right</p>		

flowers

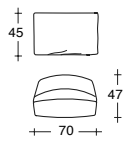

F613 **Cuscino Schienale**
 Back Cushion
 Coussin de dossier
 Rückenkissen
 Cojín de respaldo



kg



m³0,18



m 1,50

Fodera di ricambio
 SpareCover
 Housse deréchange
 Ersatzbezug
 Funda



F614 **Bracciolo**
 Arm cushion
 Coussin d'accoudoire
 Armlehnkissen
 Cojín de brazo



kg



m³0,10



m 1,00

Fodera di ricambio
 SpareCover
 Housse deréchange
 Ersatzbezug
 Funda

flowers

Composizione - Composition - Composition - Gruppe - Composición C1

F605 sx Isola cm. 245
Isle cm.245

F601 Base cm.200
Ottoman cm.200

4-F613 4 Cuscini Schienale
4 Back cushion

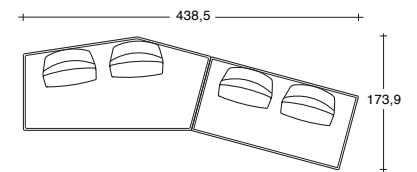
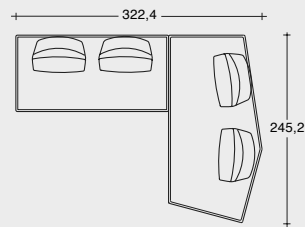
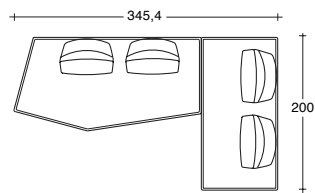
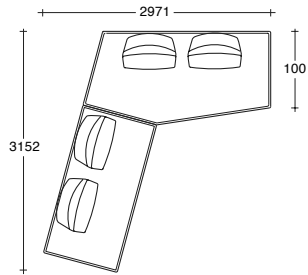

Composizione - Composition - Composition - Gruppe - Composición C2

F605 sx Isola cm. 245
Isle cm.245

F611 sx Isola cm.112
Isle cm.112

3-F613 3 Cuscini Schienale
3 Back cushion

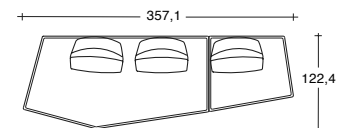
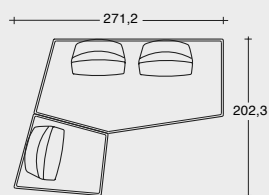
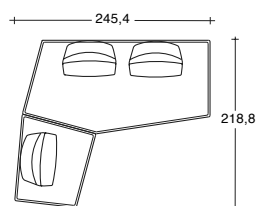
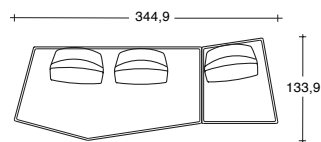

flowers

Composizione - Composition - Composition - Gruppe - Composición C3

F605 sx Isola cm. 245
Isle cm.245

2-F611 sx 2 Isola cm.112
2 Isle cm.112

3-F613 3 Cuscini Schienale
3 Back cushion

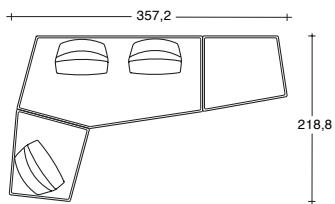
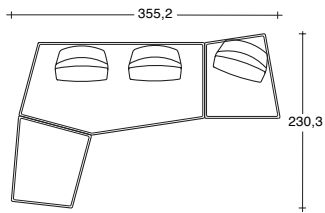

Composizione - Composition - Composition - Gruppe - Composición C4

2-F605 sx 2 Isola cm. 245
2 Isle cm.245

4-F613 4 Cuscini Schienale
4 Back cushion

