

# norton

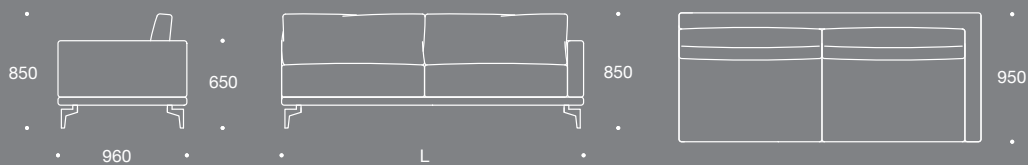

## Dimensioni

Dimensions - Masse - Dimension - Tamaño



## Piedini

Metallo finitura in titanio

**Legs** - Metal feet, finishing in titanium

**Fuesse** - Pieds en acier finition en titan

**Pieds** - Füße in Metall, Ausführung in Titanium

**Pies** - Patas en metal, acabado en titanio



## Di serie

Standard - Standard

Standard - Estándar

## Cuciture optional

Sewings - Naehnte - Coutures - Costuras



### Bordo canneté colorato

Piping with colored gross grain - Passepoil avec gross grain coloré - Keder mit buntem Gross Grain - canneté coloreado

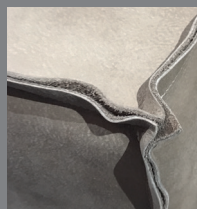

### Bordo al vivo (pelle)

Open cut sewing (leather) - Couture ouverte (cuir) - Offenkantige Naht (Leder) - Costuras abiertas (cuero)



### Taglio vivo con cucitura rovesciata (pelle)

Open cut inverted sewing (leather) - Couture ouverte invertie (cuir) - Offenkantige umgekehrte Naht (Leder) - Costuras abiertas volcadas (cuero)



### Filo cucitura contrasto (tessuto-pelle)

Sewing thread in contrasting color (fabric-leather) - Fil couture contrastant (tissu et cuir) - Naht in Kontrastfarbe (Stoff-Leder) - Costura con color de contraste



### Chiusa

Closed Feste Naht Couture fermée Costura cerrada

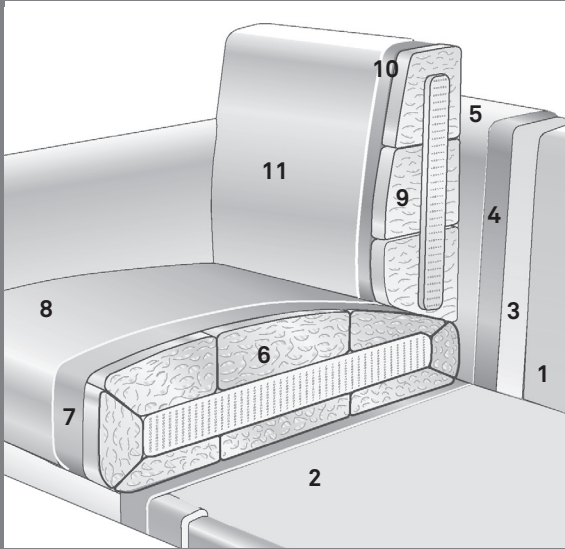

## Struttura

Structure - Struktur  
Structure - Estructura

### 1. Fusto legno

Wood structure - Structure en bois  
Holzstruktur - Estructura de madera

### 2. Fondo scocca in legno

Base structure in wood  
La base de la structure en bois  
Basis der Struktur in Holz  
La base de la estructura de madera

### 3. Gomma

Foam - Poliurethanschaum  
Mousse - Poliuretano

### 4. Rivestimento

Cover - Bezug - Housse  
Revestimiento

### 5. Tessuto

Fabric - Stoff - Tissu - Tela

## Cuscino seduta

Seat cushion - Sitzkissen  
Coussin de siège - Cojín del asiento

### 6. Gomma quote differenziate con malva Foam

Foam with differentiated thickness and Malvafoam - Mousse de Polyuréthane et Malva Mousse - Polyuréthanschaum mit Malvaschaum  
Goma en Polyuréthane y Goma Malva

### 7. Resinato

Resinate - Harzschaum  
Resine mousse - Resina de goma

### 8. Tessuto

Fabric - Stoff - Tissu - Tela

## Cuscino schienale

Back cushion - Rueckenkissen  
Coussins de dossier - Cojines de respaldo

### 9. Piuma sterilizzata e siliconata

Sterilized and siliconized feathers  
Plumes stérilisés et silicones  
Sterilisierte und mit Silikon behandelte Federn  
Pluma esterilizada y siliconada











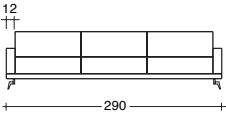



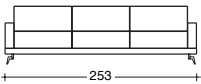



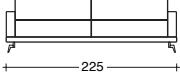



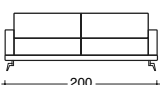



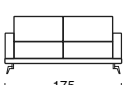



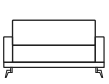

### 10. Resinato

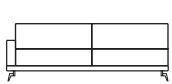
Resinate - Harzschaum  
Resine mousse - Resina de goma

### 11. Tessuto

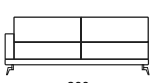
Fabric - Stoff - Tissu - Tela

# norton

	<p><b>D601</b> <b>Divano 4 POSTI MAXI</b> Sofa 4 seaters MAXI Canapé 4 places MAXI Sofa 4-Sitzer MAXI Sofa 4 asientos MAXI</p>	 kg 100	 m <sup>3</sup> 2,00	 m 17,50	<p><b>Fodera di ricambio</b> SpareCover Housse deréchange Ersatzbezug Funda</p>
	<p><b>D602</b> <b>Divano 4 POSTI</b> Sofa 4 seaters Canapé 4 places Sofa 4-Sitzer Sofa 4 asientos</p>	 kg 80	 m <sup>3</sup> 1,80	 m 15,50	<p><b>Fodera di ricambio</b> SpareCover Housse deréchange Ersatzbezug Funda</p>
	<p><b>D603</b> <b>Divano 3 POSTI</b> Sofa 3 seaters Canapé 3 places Sofa 3-Sitzer Sofa 3 asientos</p>	 kg 70	 m <sup>3</sup> 1,60	 m 11,00	<p><b>Fodera di ricambio</b> SpareCover Housse deréchange Ersatzbezug Funda</p>
	<p><b>D604</b> <b>Divano MEDIO</b> Sofa medium Canapé medium Sofa medium Sofa medio</p>	 kg 65	 m <sup>3</sup> 1,40	 m 10,20	<p><b>Fodera di ricambio</b> SpareCover Housse deréchange Ersatzbezug Funda</p>
	<p><b>D605</b> <b>Divano 2 POSTI</b> Sofa 2 seaters Canapé 2 places Sofa 2-Sitzer Sofa 2 asientos</p>	 kg 63	 m <sup>3</sup> 1,26	 m 9,80	<p><b>Fodera di ricambio</b> SpareCover Housse deréchange Ersatzbezug Funda</p>
	<p><b>D606</b> <b>POLTRONA</b> Armchair Fauteuil Sessel Butaca</p>	 kg 50	 m <sup>3</sup> 1,00	 m 7,00	<p><b>Fodera di ricambio</b> SpareCover Housse deréchange Ersatzbezug Funda</p>
 <p>sx-left</p>	<p><b>D607</b> <b>Laterale 3 POSTI</b> Lateral 3 seaters Laterale 3 places Seitenelement 3-Sitzer <b>D608</b> Lateral 3 asientos dx-right</p>	 kg 65	 m <sup>3</sup> 1,60	 m 10,00	<p><b>Fodera di ricambio</b> SpareCover Housse deréchange Ersatzbezug Funda</p>
 <p>sx-left</p>	<p><b>D609</b> <b>Laterale MEDIO</b> Lateral medium Laterale medium Seitenelement me- dium <b>D610</b> Lateral medio dx-right</p>	 kg 60	 m <sup>3</sup> 1,40	 m 9,20	<p><b>Fodera di ricambio</b> SpareCover Housse deréchange Ersatzbezug Funda</p>

# norton

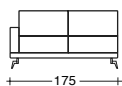

sx-left

**D611** Laterale 2 POSTI  
sx-left  
Lateral 2 seaters  
Laterale 2 places  
Seitenelement  
2-Sitzer  
**D612** dx-right  
Lateral 2 asientos



kg 60



m<sup>3</sup> 1,26



m 8,80

**Fodera di ricambio**  
SpareCover  
Housse deréchange  
Ersatzbezug  
Funda

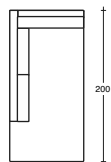

sx-left

**D613** Penisola cm 200x96  
sx-left  
Peninsula 200x96  
Peninsule 200x96  
Halbinsel 200x96  
**D614** dx-right  
Península 200x96



kg 65



m<sup>3</sup> 1,40



m 10,00

**Fodera di ricambio**  
SpareCover  
Housse deréchange  
Ersatzbezug  
Funda

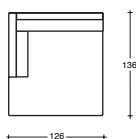

sx-left

**D615** Chaise longue cm 126x136  
sx-left  
Chaise longue 126x136  
Chaise longue 126x136  
**D616** dx-right  
Chaise longue 126x136  
Chaise longue 126x136



kg 50



m<sup>3</sup> 1,30



m 8,00

**Fodera di ricambio**  
SpareCover  
Housse deréchange  
Ersatzbezug  
Funda

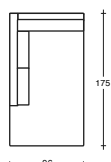

sx-left

**D617** Penisola cm 175x96  
sx-left  
Peninsula 175x96  
Peninsule 175x96  
Halbinsel 175x96  
**D618** dx-right  
Península 175x96



kg 55



m<sup>3</sup> 1,26



m 9,00

**Fodera di ricambio**  
SpareCover  
Housse deréchange  
Ersatzbezug  
Funda

Composizione - Composition - Composition - Gruppe - Composición C1

- D609 sx** Laterale MEDIO  
Lateral medium left
- D614 dx** Penisola 200x96  
Peninsula 200x96 right

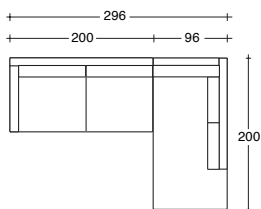

Composizione - Composition - Composition - Gruppe - Composición C2

- D609 sx** Laterale MEDIO  
Lateral medium left
- D618 dx** Penisola 175x96  
Peninsula 175x96 right

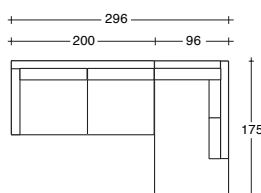

Composizione - Composition - Composition - Gruppe - Composición C3

- D607 sx** Laterale 3 POSTI  
Lateral 3 seaters left
- D614 dx** Penisola 200x96  
Peninsula 200x96 right

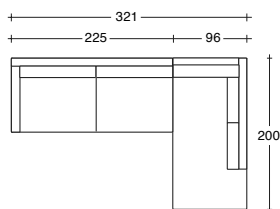

Composizione - Composition - Composition - Gruppe - Composición C4

- D607 sx** Laterale 3 POSTI  
Lateral 3 seaters left
- D618 dx** Penisola 175x96  
Peninsula 175x96 right

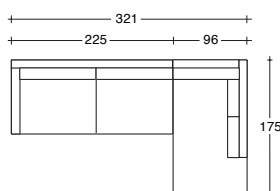

Composizione - Composition - Composition - Gruppe - Composición C5

- D611 sx** Laterale 2 POSTI  
Lateral 2 seaters left
- D614 dx** Penisola 200x96  
Peninsula 200x96 right

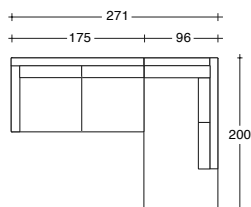

Composizione - Composition - Composition - Gruppe - Composición C6

- D611 sx** Laterale 2 POSTI  
Lateral 2 seaters left
- D618 dx** Penisola 175x96  
Peninsula 175x96 right

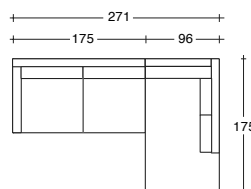

Composizione - Composition - Composition - Gruppe - Composición C7

- D609 sx** Laterale MEDIO  
Lateral medium left
- D616 dx** Chaise longue 126x136  
Chaise longue 126x136 right

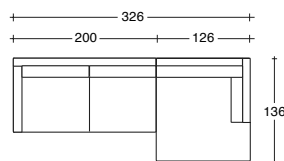

Composizione - Composition - Composition - Gruppe - Composición C8

- D611 sx** Laterale 2 posti  
Lateral 2 seaters left
- D616 dx** Chaise longue 126x136  
Chaise longue 126x136 right

