

william

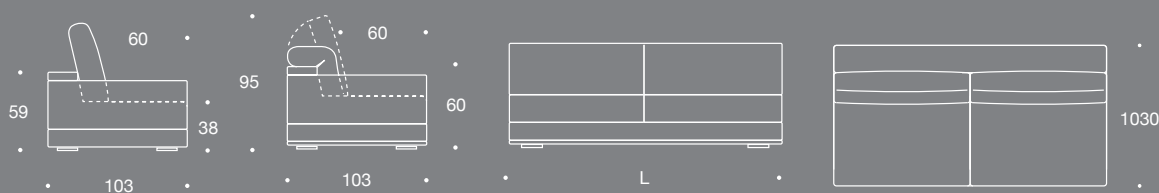

Dimensioni

Dimensions - Masse - Dimension - Tamaño



Piedini

Metallo finitura in titanio o verniciato nero opaco.

Legs - Metal feet, finishing in titanium or black matt lacquered. - **Fuesse** - Pieds en acier finition en titan ou vernis noir mat. - **Pieds** - FüÙe in Metall, Ausführung in Titanium oder matt-schwarz lackiert. - **Pies** - Patas en metal, acabado en titanio o lacado en negro deslucido.



Piedini

in legno con opzione barra e alluminio cromato

Piedini in legno con opzione barra e alluminio cromato - Wooden legs, with chromed bar option - Pieds en bois avec d'options de bar chromé en aluminium - Holzfuß mit Option einer verchromten Fußleiste

Cuciture optional

Sewings - Naehete - Coutures - Costuras



Filo cucitura contrasto (tessuto-pelle)

Sewing thread in contrasting color (fabric-leather) - Fil couture contrastant (tissu et cuir) - Naht in Kontrastfarbe (Stoff-Leder) - Costura con color de contraste

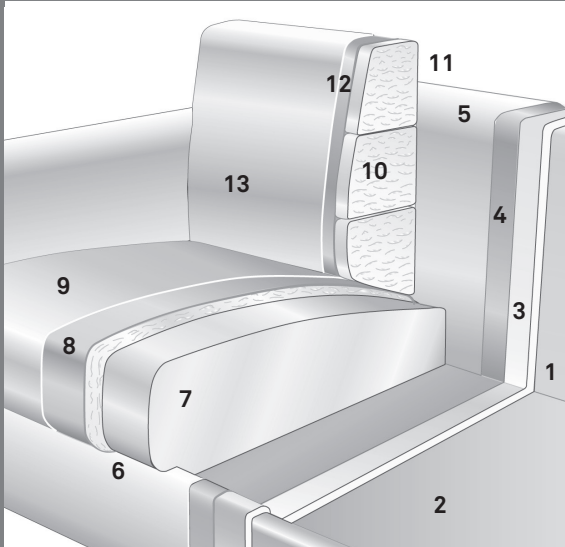

Struttura

Structure - Struktur
Structure - Estructura

1. Fusto legno

Wood structure - Structure en bois
Holzstruktur - Estructura de madera

2. Fondo scocca in legno

Base structure in wood
La base de la structure en bois
Basis der Struktur in Holz
La base de la estructura de madera

3. Gomma

Foam - Poliurethanschaum
Mousse - Poliuretano

4. Rivestimento

Cover - Bezug - Housse
Revestimiento

5. Tessuto

Fabric - Stoff - Tissu - Tela

Meccanismo

Mechanism - Hebe Mechanismus - Mécanisme - Mecanismo



Vedi colori a catalogo

See colors in the catalogue - Siehe Farben im Katalog - Voir les couleurs dans le catalogue - Ver el color en el catálogo

Cuscino seduta

Seat cushion - Sitzkissen
Coussin de siège - Cojín del asiento

6. Cuscino ad incastro e con antiscivolo

No-slip seat cushion
Coussin d'assise antidérapant
Rutschfeste Sitzkissen
Cojines de sentada antidesliz

7. Gomma a quote differenziate più malva

Foam - Poliurethanschaum
Mousse - Poliuretano

8. Resinato

Resinate - Harzschaum
Resine mousse - Resina de goma

9. Tessuto

Fabric - Stoff - Tissu - Tela

Cuscino schienale

Back cushion - Rueckenkissen
Coussins de dossier - Cojines de respaldo

10. Misto piuma sterilizzata e siliconata

Sterilized and siliconized feather Mix
Stérilisés et siliconés mix des plumes
Sterilisierte und mit Silikon behandelte
Federmischung -
Mix de pluma esterilizada y silicona

11. Cuscino con opzione meccanismo alza schiena in metallo con doppio pistone

Pillow with option of backrest mechanism with double pistons -
Coussin avec possibilité de mécanisme de dossier avec deux pistons -
Rückenkissen mit Möglichkeit einer Hebefunktion mit doppelten Gaskolben
Cojín con la opción del mecanismo de respaldo con pistones dobles

12. Resinato

Resinate - Harzschaum
Resine mousse - Resina de goma

13. Tessuto

Fabric - Stoff - Tissu - Tela











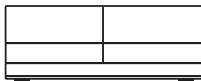



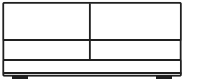











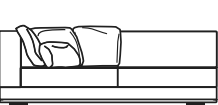
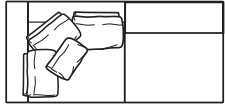



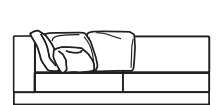
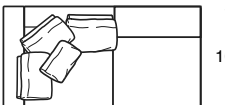

Meccanismo schiena e base metallo INCLUSO

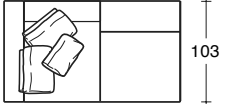
Backrest mechanism and chrome-plated bar INCLUDED in the price

Mécanisme dossier et barre chromé COMPRIS dans le prix

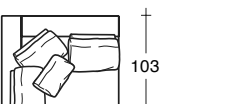
Rückenlehnenmechanismus und verchromter Fussleiste im Preis ENTHALTEN

Mecanismo respaldo y barra cromada INCLUIDOS en el precio

 <p>200</p>	<p>C113 Elemento centrale cm 200 Central element cm 200 Centrale cm 200 Mittel Element cm 200 Elemento central cm 200</p>	 kg72  m ³ 1,4  m12	<p>Fodera di ricambio SpareCover Housse deréchange Ersatzbezug Funda</p>
 <p>180</p>	<p>C114 Elemento centrale cm 180 Central element cm 180 Centrale cm 180 Mittel Element cm 180 Elemento central cm 180</p>	 kg70  m ³ 1,3  m12	<p>Fodera di ricambio SpareCover Housse deréchange Ersatzbezug Funda</p>
 <p>160</p>	<p>C115 Elemento centrale cm 160 Central element cm 160 Centrale cm 160 Mittel Element cm 160 Elemento central cm 160</p>	 kg65  m ³ 1,15  m11	<p>Fodera di ricambio SpareCover Housse deréchange Ersatzbezug Funda</p>
 <p>100</p>	<p>C116 Elemento centrale cm 100 Central element cm 100 Centrale cm 100 Mittel Element cm 100 Elemento central cm 100</p>	 kg48  m ³ 0,7  m7,5	<p>Fodera di ricambio SpareCover Housse deréchange Ersatzbezug Funda</p>
  <p>103</p> <p>220</p> <p>sx-left</p>	<p>C285 Penisola cm 220 Peninsula cm 220 Peninsule cm 220 Halbinsel cm 220 Península cm 220</p> <p>sx-left</p> <p>C286 Peninsula cm 220</p> <p>dx-right</p>	 kg86  m ³ 1,68  m14	<p>Fodera di ricambio SpareCover Housse deréchange Ersatzbezug Funda</p>
  <p>103</p> <p>200</p> <p>sx-left</p>	<p>C287 Penisola cm 200 Peninsula cm 200 Peninsule cm 200 Halbinsel cm 200 Peninsula cm 200</p> <p>sx-left</p> <p>C288 Peninsula cm 200</p> <p>dx-right</p>	 kg86  m ³ 1,4  m14	<p>Fodera di ricambio SpareCover Housse deréchange Ersatzbezug Funda</p>
  <p>103</p> <p>180</p> <p>sx-left</p>	<p>C289 Penisola cm 180 Peninsula cm 180 Peninsule cm 180 Halbinsel cm 180 Peninsula cm 180</p> <p>sx-left</p> <p>C290 Peninsula cm 180</p> <p>dx-right</p>	 kg85  m ³ 1,15  m13	<p>Fodera di ricambio SpareCover Housse deréchange Ersatzbezug Funda</p>
  <p>103</p> <p>120</p> <p>sx-left</p>	<p>C291 Penisola cm 120 Peninsula cm 120 Peninsule cm 120 Halbinsel cm 120 Peninsula cm 120</p> <p>sx-left</p> <p>C292 Peninsula cm 120</p> <p>dx-right</p>	 kg49  m ³ 0,95  m9	<p>Fodera di ricambio SpareCover Housse deréchange Ersatzbezug Funda</p>

Meccanismo per poltrona*

Mechanism for armchair / Mécanisme pour fauteuil
 Mechanismus für Sessel / Mecánismo por sillón

€uro 420,00

Meccanismo per divano

Mechanism for sofa / Mécanisme pour canapé
 Mechanismus für Sofa / Mecánismo por sofá

€uro 840,00

Specificare con o senza meccanismo

Point out with or without mechanism
 Spécifier toujours avec ou sans mécanisme
 Mit oder ohne Mechanismus mitteilen
 Indicar con o sin mecánismo

Base metallo

Chrome-plated bar
 Barre chromé
 Verchromte Fussleiste
 Barra cromada

€uro 160,00











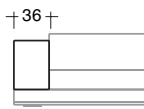



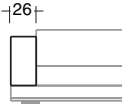



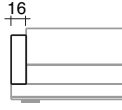



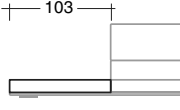



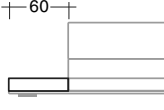



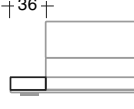

Meccanismo schiena e base metallo INCLUSO

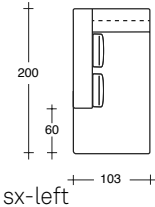
Backrest mechanism and chrome-plated bar INCLUDED in the price

Mécanisme dossier et barre chromé COMPRIS dans le prix

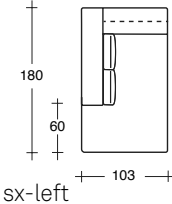
Rückenlehnmechanismus und verchromter Fussleiste im Preis ENTHALTEN

Mecanismo respaldo y barra cromada INCLUIDOS en el precio

 <p>↑36↑</p>	<p>C305 Bracciolo 36 Arm 36 Accoudoir 36 Armlehne 36 C304 Brazo 36</p>	 kg 11	 m ³ 0,3	 m 1,5	<p>Fodera di ricambio SpareCover Housse deréchange Ersatzbezug Funda</p>
 <p>↑26↑</p>	<p>C307 Bracciolo 26 Arm 26 Accoudoir 26 Armlehne 26 C306 Brazo 26</p>	 kg 10	 m ³ 0,3	 m 1,4	<p>Fodera di ricambio SpareCover Housse deréchange Ersatzbezug Funda</p>
 <p>↑16↑</p>	<p>C309 Bracciolo 16 Arm 16 Accoudoir 16 Armlehne 16 C308 Brazo 16</p>	 kg 9	 m ³ 0,25	 m 1,3	<p>Fodera di ricambio SpareCover Housse deréchange Ersatzbezug Funda</p>
 <p>↑103↑</p>	<p>C311 Piano 103 Platform 103 Plan d'appui 103 Ablage 103 C310 Plano de apoyo 103</p>	 kg 20	 m ³ 0,6	 m 2,1	<p>Fodera di ricambio SpareCover Housse deréchange Ersatzbezug Funda</p>
 <p>↑60↑</p>	<p>C313 Piano 60 Platform 60 Plan d'appui 60 Ablage 60 C312 Plano de apoyo 60</p>	 kg 10	 m ³ 0,45	 m 1,6	<p>Fodera di ricambio SpareCover Housse deréchange Ersatzbezug Funda</p>
 <p>↑36↑</p>	<p>C315 Piano 36 Platform 36 Plan d'appui 36 Ablage 36 C314 Plano de apoyo 36</p>	 kg 9	 m ³ 0,4	 m 1,4	<p>Fodera di ricambio SpareCover Housse deréchange Ersatzbezug Funda</p>
 <p>↑200↑ ↑60↑ ↑103↑</p>	<p>C317 Chaise longue 103x200 Chaise longue 103x200 Chaise longue 103x200 Chaise longue 103x200 C316 Chaise longue 103x200</p>	 kg 75	 m ³ 1,3	 m 12	<p>Fodera di ricambio SpareCover Housse deréchange Ersatzbezug Funda</p>
 <p>↑180↑ ↑60↑ ↑103↑</p>	<p>C319 Chaise longue 103x180 Chaise longue 103x180 Chaise longue 103x180 Chaise longue 103x180 C318 Chaise longue 103x180</p>	 kg 72	 m ³ 1,2	 m 11	<p>Fodera di ricambio SpareCover Housse deréchange Ersatzbezug Funda</p>

Meccanismo per poltrona*

Mechanism for armchair / Mécanisme pour fauteuil
Mechanismus für Sessel / Mecánismo por sillón

€uro 420,00

Meccanismo per divano

Mechanism for sofa / Mécanisme pour canapé
Mechanismus für Sofa / Mecánismo por sofá

€uro 840,00

Specificare con o senza meccanismo

Point out with or without mechanism
Spécifier toujours avec ou sans mécanisme
Mit oder ohne Mechanismus mitteilen
Indicar con o sin mecánismo











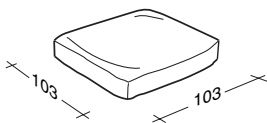



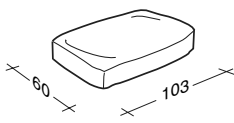



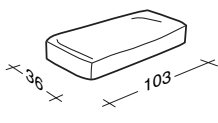



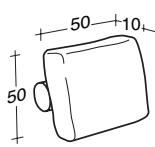



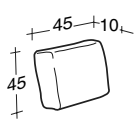



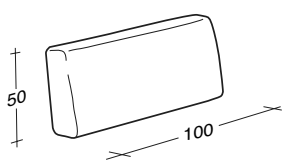

Base metallo

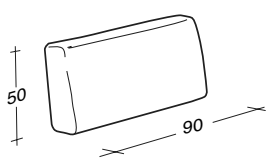
Chrome-plated bar
Barre chromé
Verchromte Fussleiste
Barra cromada

€uro 160,00

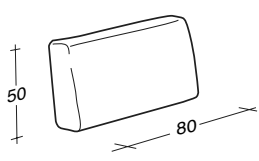
Meccanismo schiena e base metallo INCLUSO

Backrest mechanism and chrome-plated bar INCLUDED in the price
 Mécanisme dossier et barre chromé COMPRIS dans le prix
 Rückenlehnenmechanismus und verchromter Fussleiste im Preis ENTHALTEN
 Mecanismo respaldo y barra cromada INCLUIDOS en el precio

	<p>C293 Cuscino piano 103 Cushion for platform 103 Coussin pour plan d'appui 103 Kissen für Ablage 103 Cojín por plano de apoyo 103</p>	 kg 11	 m ³ 0,18	 m4	<p>Fodera di ricambio SpareCover Housse deréchange Ersatzbezug Funda</p>
	<p>C294 Cuscino piano 60 Cushion for platform 60 Coussin pour plan d'appui 60 Kissen für Ablage 60 Cojín por plano de apoyo 60</p>	 kg 7	 m ³ 0,1	 m4	<p>Fodera di ricambio SpareCover Housse deréchange Ersatzbezug Funda</p>
	<p>C295 Cuscino piano 36 Cushion for platform 36 Coussin pour plan d'appui 36 Kissen für Ablage 36 Cojín por plano de apoyo 36</p>	 kg 4	 m ³ 0,8	 m3,5	<p>Fodera di ricambio SpareCover Housse deréchange Ersatzbezug Funda</p>
	<p>C296 Cuscino schienale 50x50 Back cushion 50x50 Coussin dossier 50x50 Rückenkissen 50x50 Cojín respaldo 50x50</p>	 kg 4	 m ³ 0,8	 m3,5	<p>Fodera di ricambio SpareCover Housse deréchange Ersatzbezug Funda</p>
	<p>C297 Cuscino bracciolo 45x45 Cushion Arm 45x45 Coussin accoudoir 45x45 Kissen Armlehne 45x45 Cojín brazo 45x45</p>	 kg 4	 m ³ 0,8	 m3,5	<p>Fodera di ricambio SpareCover Housse deréchange Ersatzbezug Funda</p>
	<p>C298 Cuscino schienale 100x50 Back cushion 100x50 Coussin dossier 100x50 Rückenkissen 100x50 Cojín respaldo 100x50</p>	 kg 5	 m ³ 0,11	 m3	<p>Fodera di ricambio SpareCover Housse deréchange Ersatzbezug Funda</p>
	<p>C299 Cuscino schienale 90x50 Back cushion 90x50 Coussin dossier 90x50 Rückenkissen 90x50 Cojín respaldo 90x50</p>	 kg 4	 m ³ 0,1	 m3	<p>Fodera di ricambio SpareCover Housse deréchange Ersatzbezug Funda</p>
	<p>C300 Cuscino schienale 80x50 Back cushion 80x50 Coussin dossier 80x50 Rückenkissen 80x50 Cojín respaldo 80x50</p>	 kg 3	 m ³ 0,08	 m2,5	<p>Fodera di ricambio SpareCover Housse deréchange Ersatzbezug Funda</p>

Meccanismo per poltrona*

Mechanism for armchair / Mécanisme pour fauteuil
 Mechanismus für Sessel / Mecánismo por sillón

€uro 420,00

Meccanismo per divano

Mechanism for sofa / Mécanisme pour canapé
 Mechanismus für Sofa / Mecánismo por sofá

€uro 840,00

Specificare con o senza meccanismo

Point out with or without mechanism
 Spécifier toujours avec ou sans mécanisme
 Mit oder ohne Mechanismus mitteilen
 Indicar con o sin mecánismo

Base metallo

Chrome-plated bar
 Barre chromé
 Verchromte Fussleiste
 Barra cromada

€uro 160,00

Meccanismo schiena e base metallo INCLUSO

Backrest mechanism and chrome-plated bar INCLUDED in the price

Mécanisme dossier et barre chromé COMPRIS dans le prix

Rückenlehnenmechanismus und verchromter Fussleiste im Preis ENTHALTEN

Mecanismo respaldo y barra cromada INCLUIDOS en el precio

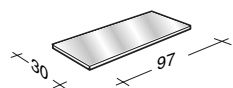

C301 **Vassoio 97x30 bianco o nero**
 Top 97x30 white/black
 Plan d'appui 97x30 blanc/noir
 Ablage 97x30 weiss/schwarz
 Plano 97x30 blanco/negro



kg 1



m³0,02



m

Fodera di ricambio
 SpareCover
 Housse deréchange
 Ersatzbezug
 Funda

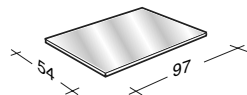

C302 **Vassoio 97x54 bianco o nero**
 Top 97x54 white/black
 Plan d'appui 97x54 blanc/noir
 Ablage 97x54 weiss/schwarz
 Plano 97x54 blanco/negro



kg 1,3



m³0,03



m

Fodera di ricambio
 SpareCover
 Housse deréchange
 Ersatzbezug
 Funda

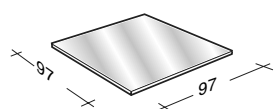

C303 **Vassoio 97x97 bianco o nero**
 Top 97x97 white/black
 Plan d'appui 97x97 blanc/noir
 Ablage 97x97 weiss/schwarz
 Plano 97x97 blanco/negro



kg 1,5



m³0,03



m

Fodera di ricambio
 SpareCover
 Housse deréchange
 Ersatzbezug
 Funda

Meccanismo per poltrona*
 Mechanism for armchair / Mécanisme pour fauteuil
 Mechanismus für Sessel / Mecánismo por sillón

€uro 420,00

Meccanismo per divano
 Mechanism for sofa / Mécanisme pour canapé
 Mechanismus für Sofa / Mecánismo por sofá

€uro 840,00















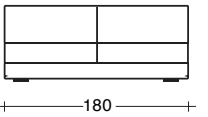



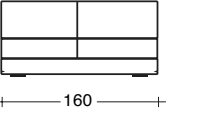



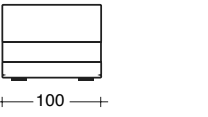



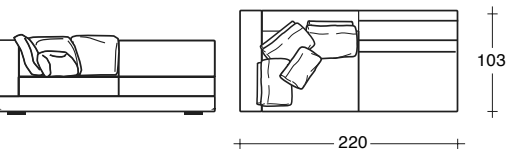



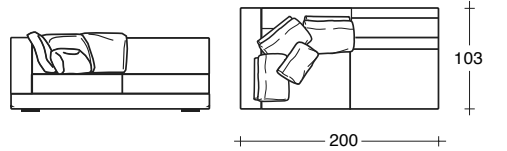

Specificare con o senza meccanismo
 Point out with or without mechanism
 Spécifier toujours avec ou sans mécanisme
 Mit oder ohne Mechanismus mitteilen
 Indicar con o sin mecánismo

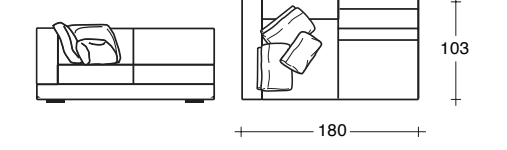
Base metallo
 Chrome-plated bar
 Barre chromé
 Verchromte Fussleiste
 Barra cromada

€uro 160,00

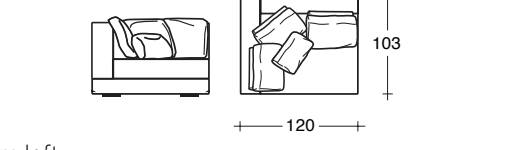









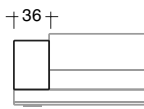



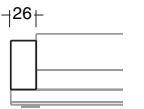



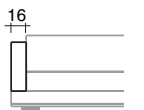



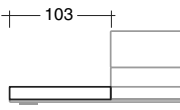



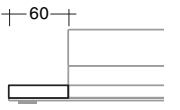



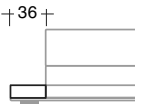

william

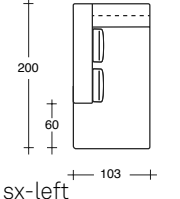
Senza meccanismo schiena e senza base metallo
 WITHOUT backrest mechanism and WITHOUT chrome-plated bar
 SANS mécanisme dossier et SANS barre chromé
 OHNE Rückenlehnenmechanismus und OHNE verchromter Fussleiste
 SIN mecanismo respaldo y SIN barra cromada

 <p>200</p>	<p>D113 Elemento centrale cm 200 Central element cm 200 Centrale cm 200 Mittel Element cm 200 Elemento central cm 200</p>	 kg72  m ³ 1,4  m12	<p>Fodera di ricambio SpareCover Housse deréchange Ersatzbezug Funda</p>
 <p>180</p>	<p>D114 Elemento centrale cm 180 Central element cm 180 Centrale cm 180 Mittel Element cm 180 Elemento central cm 180</p>	 kg70  m ³ 1,3  m12	<p>Fodera di ricambio SpareCover Housse deréchange Ersatzbezug Funda</p>
 <p>160</p>	<p>D115 Elemento centrale cm 160 Central element cm 160 Centrale cm 160 Mittel Element cm 160 Elemento central cm 160</p>	 kg65  m ³ 1,15  m11	<p>Fodera di ricambio SpareCover Housse deréchange Ersatzbezug Funda</p>
 <p>100</p>	<p>D116 Elemento centrale cm 100 Central element cm 100 Centrale cm 100 Mittel Element cm 100 Elemento central cm 100</p>	 kg48  m ³ 0,7  m7,5	<p>Fodera di ricambio SpareCover Housse deréchange Ersatzbezug Funda</p>
 <p>103</p> <p>220</p> <p>sx-left</p>	<p>D285 Penisola cm 220 Peninsula cm 220 Peninsule cm 220 Halbinsel cm 220 Península cm 220</p> <p>D286 dx-right</p>	 kg86  m ³ 1,68  m14	<p>Fodera di ricambio SpareCover Housse deréchange Ersatzbezug Funda</p>
 <p>103</p> <p>200</p> <p>sx-left</p>	<p>D287 Penisola cm 200 Peninsula cm 200 Peninsule cm 200 Halbinsel cm 200</p> <p>D288 Península cm 200 dx-right</p>	 kg86  m ³ 1,4  m14	<p>Fodera di ricambio SpareCover Housse deréchange Ersatzbezug Funda</p>
 <p>103</p> <p>180</p> <p>sx-left</p>	<p>D289 Penisola cm 180 Peninsula cm 180 Peninsule cm 180 Halbinsel cm 180</p> <p>D290 Península cm 180 dx-right</p>	 kg85  m ³ 1,15  m13	<p>Fodera di ricambio SpareCover Housse deréchange Ersatzbezug Funda</p>
 <p>103</p> <p>120</p> <p>sx-left</p>	<p>D291 Penisola cm 120 Peninsula cm 120 Peninsule cm 120 Halbinsel cm 120</p> <p>D292 Península cm 120 dx-right</p>	 kg49  m ³ 0,95  m9	<p>Fodera di ricambio SpareCover Housse deréchange Ersatzbezug Funda</p>

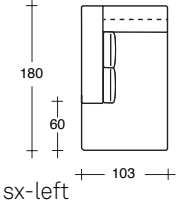









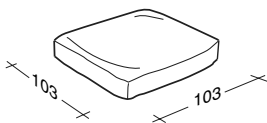



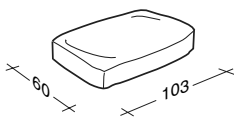



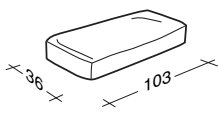



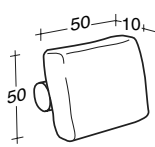



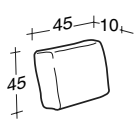



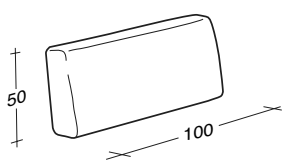

Base metallo
 Chrome-plated bar
 Barre chromé
 Verchromte Fussleiste
 Barra cromada

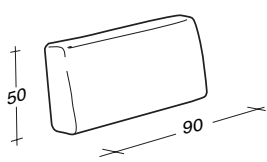
€uro 160,00

 <p>↑36↑</p>	<p>C305 Bracciolo 36 Arm 36 Accoudoir 36 Armlehne 36 C304 Brazo 36</p> <p>sx-left dx-right</p>	<p> kg 11  m³0,3  m 1,5</p>	<p>Fodera di ricambio SpareCover Housse deréchange Ersatzbezug Funda</p>
 <p>↑26↑</p>	<p>C307 Bracciolo 26 Arm 26 Accoudoir 26 Armlehne 26 C306 Brazo 26</p> <p>sx-left dx-right</p>	<p> kg 10  m³0,3  m 1,4</p>	<p>Fodera di ricambio SpareCover Housse deréchange Ersatzbezug Funda</p>
 <p>↑16↑</p>	<p>C309 Bracciolo 16 Arm 16 Accoudoir 16 Armlehne 16 C308 Brazo 16</p> <p>sx-left dx-right</p>	<p> kg 9  m³0,25  m 1,3</p>	<p>Fodera di ricambio SpareCover Housse deréchange Ersatzbezug Funda</p>
 <p>↑103↑</p>	<p>C311 Piano 103 Platform 103 Plan d'appui 103 Ablage 103 C310 Plano de apoyo 103</p> <p>sx-left dx-right</p>	<p> kg 20  m³0,6  m 2,1</p>	<p>Fodera di ricambio SpareCover Housse deréchange Ersatzbezug Funda</p>
 <p>↑60↑</p>	<p>C313 Piano 60 Platform 60 Plan d'appui 60 Ablage 60 C312 Plano de apoyo 60</p> <p>sx-left dx-right</p>	<p> kg 10  m³0,45  m 1,6</p>	<p>Fodera di ricambio SpareCover Housse deréchange Ersatzbezug Funda</p>
 <p>↑36↑</p>	<p>C315 Piano 36 Platform 36 Plan d'appui 36 Ablage 36 C314 Plano de apoyo 36</p> <p>sx-left dx-right</p>	<p> kg 9  m³0,4  m 1,45</p>	<p>Fodera di ricambio SpareCover Housse deréchange Ersatzbezug Funda</p>
 <p>↑200↑ ↑60↑ ↑103↑</p>	<p>D317 Chaise longue 103x200 Chaise longue 103x200 Chaise longue 103x200 D316 Chaise longue 103x200</p> <p>sx-left dx-right</p>	<p> kg 75  m³1,3  m 12</p>	<p>Fodera di ricambio SpareCover Housse deréchange Ersatzbezug Funda</p>
 <p>↑180↑ ↑60↑ ↑103↑</p>	<p>D319 Chaise longue 103x180 Chaise longue 103x180 Chaise longue 103x180 D318 Chaise longue 103x180</p> <p>sx-left dx-right</p>	<p> kg 72  m³1,2  m 11</p>	<p>Fodera di ricambio SpareCover Housse deréchange Ersatzbezug Funda</p>

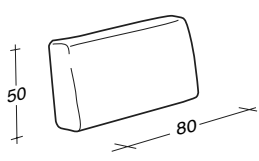
Base metallo
 Chrome-plated bar
 Barre chromé
 Verchromte Fussleiste
 Barra cromada

€uro 160,00

	<p>C293 Cuscino piano 103 Cushion for platform 103 Coussin pour plan d'appui 103 Kissen für Ablage 103 Cojín por plano de apoyo 103</p>	 kg 11  m ³ 0,18  m4	<p>Fodera di ricambio SpareCover Housse deréchange Ersatzbezug Funda</p>
	<p>C294 Cuscino piano 60 Cushion for platform 60 Coussin pour plan d'appui 60 Kissen für Ablage 60 Cojín por plano de apoyo 60</p>	 kg 7  m ³ 0,1  m4	<p>Fodera di ricambio SpareCover Housse deréchange Ersatzbezug Funda</p>
	<p>C295 Cuscino piano 36 Cushion for platform 36 Coussin pour plan d'appui 36 Kissen für Ablage 36 Cojín por plano de apoyo 36</p>	 kg 4  m ³ 0,8  m3,5	<p>Fodera di ricambio SpareCover Housse deréchange Ersatzbezug Funda</p>
	<p>C296 Cuscino schienale 50x50 Back cushion 50x50 Coussin dossier 50x50 Rückenkissen 50x50 Cojín respaldo 50x50</p>	 kg 4  m ³ 0,8  m3,5	<p>Fodera di ricambio SpareCover Housse deréchange Ersatzbezug Funda</p>
	<p>C297 Cuscino bracciolo 45x45 Cushion Arm 45x45 Coussin accoudoir 45x45 Kissen Armlehne 45x45 Cojín brazo 45x45</p>	 kg 4  m ³ 0,8  m3,5	<p>Fodera di ricambio SpareCover Housse deréchange Ersatzbezug Funda</p>
	<p>C298 Cuscino schienale 100x50 Back cushion 100x50 Coussin dossier 100x50 Rückenkissen 100x50 Cojín respaldo 100x50</p>	 kg 5  m ³ 0,11  m3	<p>Fodera di ricambio SpareCover Housse deréchange Ersatzbezug Funda</p>
	<p>C299 Cuscino schienale 90x50 Back cushion 90x50 Coussin dossier 90x50 Rückenkissen 90x50 Cojín respaldo 90x50</p>	 kg 4  m ³ 0,1  m3	<p>Fodera di ricambio SpareCover Housse deréchange Ersatzbezug Funda</p>
	<p>C300 Cuscino schienale 80x50 Back cushion 80x50 Coussin dossier 80x50 Rückenkissen 80x50 Cojín respaldo 80x50</p>	 kg 3  m ³ 0,08  m2,5	<p>Fodera di ricambio SpareCover Housse deréchange Ersatzbezug Funda</p>

Base metallo
 Chrome-plated bar
 Barre chromé
 Verchromte Fussleiste
 Barra cromada

€uro 160,00

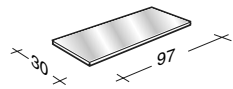

C301 Vassoio 97x30 bianco o nero
 Top 97x30 white/black
 Plan d'appui 97x30 blanc/noir
 Ablage 97x30 weiss/schwarz
 Plano 97x30 blanco/negro



kg 1



m³0,02



m

Fodera di ricambio
 SpareCover
 Housse deréchange
 Ersatzbezug
 Funda

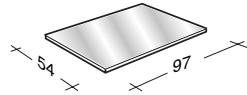

C302 Vassoio 97x54 bianco o nero
 Top 97x54 white/black
 Plan d'appui 97x54 blanc/noir
 Ablage 97x54 weiss/schwarz
 Plano 97x54 blanco/negro



kg 1,3



m³0,03



m

Fodera di ricambio
 SpareCover
 Housse deréchange
 Ersatzbezug
 Funda

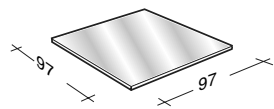

C303 Vassoio 97x97 bianco o nero
 Top 97x97 white/black
 Plan d'appui 97x97 blanc/noir
 Ablage 97x97 weiss/schwarz
 Plano 97x97 blanco/negro



kg 1,5



m³0,03



m

Fodera di ricambio
 SpareCover
 Housse deréchange
 Ersatzbezug
 Funda

william

Composizione - Composition - Composition - Gruppe - Composición 1/A

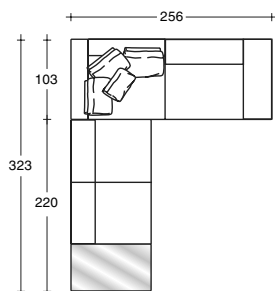

- C313 sx** Piano 60
Platform 60 left
- C302** Vassoio 97x54 bianco o nero
Top 97x54 white/black
- C115** Elemento centrale cm 160
Central element cm 160
- C285 sx** Penisola cm 220
Peninsula cm 220 left
- C304 dx** Bracciolo 36
Arm 36 right

Composizione - Composition - Composition - Gruppe - Composición 1/B

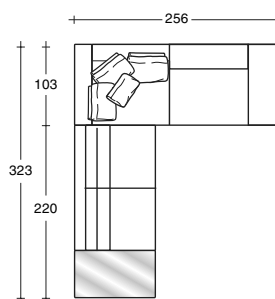

- C313 sx** Piano 60
Platform 60 left
- C302** Vassoio 97x54 bianco o nero
Top 97x54 white/black
- D115** Elemento centrale cm 160
Central element cm 160
- C285 sx** Penisola cm 220
Peninsula cm 220 left
- C304 dx** Bracciolo 36
Arm 36 right

Composizione - Composition - Composition - Gruppe - Composición 1/C

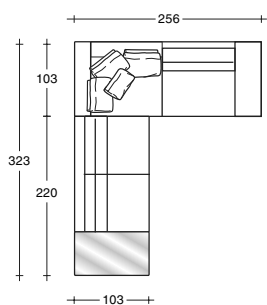

- C313 sx** Piano 60
Platform 60 left
- C302** Vassoio 97x54 bianco o nero
Top 97x54 white/black
- D115** Elemento centrale cm 160
Central element cm 160
- D285 sx** Penisola cm 220
Peninsula cm 220 left
- C304 dx** Bracciolo 36
Arm 36 right

Composizione - Composition - Composition - Gruppe - Composición 1/D

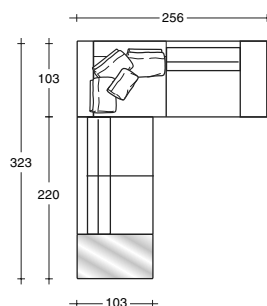

- C313 sx** Piano 60
Platform 60 left
- C302** Vassoio 97x54 bianco o nero
Top 97x54 white/black
- D115** Elemento centrale cm 160
Central element cm 160
- D285 sx** Penisola cm 220
Peninsula cm 220 left
- C304 dx** Bracciolo 36
Arm 36 right

william

Composizione - Composition - Composition - Gruppe - Composición 2/C

Meccanismo schiena e base metallo INCLUSO
Backrest mechanism and chrome-plated bar INCLUDED
in the price

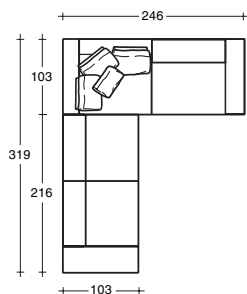

- C305 sx** Bracciolo 36
Arm 36 left
- C114** Elemento centrale cm
180
Central element cm 180
- C285 sx** Penisola cm 220
Peninsula cm 220 left
- C306 dx** Bracciolo 26
Arm 26 right

Composizione - Composition - Composition - Gruppe - Composición 2/D

Senza meccanismo schiena e senza base metallo
WITHOUT backrest mechanism and WITHOUT chrome-
plated bar

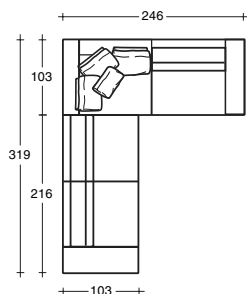

- C305 sx** Bracciolo 36
Arm 36 left
- D114** Elemento centrale cm
180
Central element cm 180
- D285 sx** Penisola cm 220
Peninsula cm 220 left
- C306 dx** Bracciolo 26
Arm 26 right

Composizione - Composition - Composition - Gruppe - Composición 3/C

Meccanismo schiena e base metallo INCLUSO
Backrest mechanism and chrome-plated bar INCLUDED
in the price

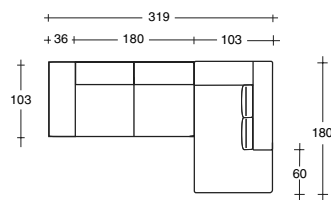

- C305 sx** Bracciolo 36
Arm 36 left
- C114** Elemento centrale cm
180
Central element cm 180
- C318 dx** Chaise longue 103x180
Chaise longue 103x180
right

Composizione - Composition - Composition - Gruppe - Composición 3/D

Senza meccanismo schiena e senza base metallo
WITHOUT backrest mechanism and WITHOUT chrome-
plated bar

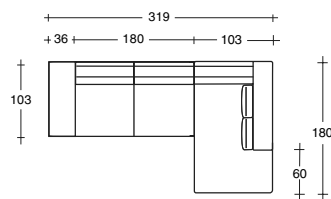

- C305 sx** Bracciolo 36
Arm 36 left
- D114** Elemento centrale cm
180
Central element cm 180
- D318 dx** Chaise longue 103x180
Chaise longue
103x180 right

william

Composizione - Composition - Composition - Gruppe - Composición 4/C

Meccanismo schiena e base metallo INCLUSO
Backrest mechanism and chrome-plated bar INCLUDED
in the price

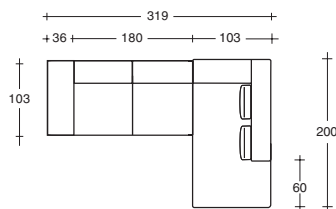

- C305 sx** Bracciolo 36
Arm 36 left
- C114** Elemento centrale cm
180
Central element cm 180
- C316 dx** Chaise longue 103x200
Chaise longue 103x200
right

Composizione - Composition - Composition - Gruppe - Composición 4/D

Senza meccanismo schiena e senza base metallo
WITHOUT backrest mechanism and WITHOUT chrome-
plated bar

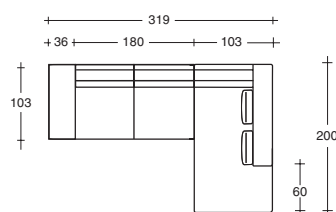

- C305 sx** Bracciolo 36
Arm 36 left
- D114** Elemento centrale cm
180
Central element cm 180
- D316 dx** Chaise longue 103x200
Chaise longue
103x200 right

Composizione - Composition - Composition - Gruppe - Composición 5/C

Meccanismo schiena e base metallo INCLUSO
Backrest mechanism and chrome-plated bar INCLUDED
in the price

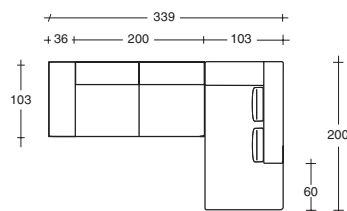

- C305 sx** Bracciolo 36
Arm 36 left
- C113** Elemento centrale cm
200
Central element cm 200
- C316 dx** Chaise longue 103x200
Chaise longue 103x200
right

Composizione - Composition - Composition - Gruppe - Composición 5/D

Senza meccanismo schiena e senza base metallo
WITHOUT backrest mechanism and WITHOUT chrome-
plated bar

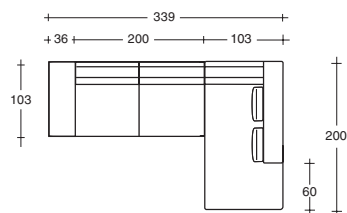

- C305 sx** Bracciolo 36
Arm 36 left
- D113** Elemento centrale cm
200
Central element cm 200
- D316 dx** Chaise longue 103x200
Chaise longue
103x200 right

william

Composizione - Composition - Composition

Meccanismo schiena e base metallo INCLUSO
Backrest mechanism and chrome-plated bar INCLUDED
in the price

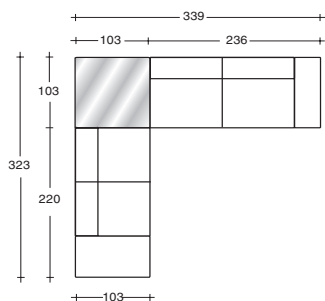

Gruppe - Composición 6/C

- C313 sx** Piano 60
Platform 60 left
- C294** Cuscino piano 60
Cushion for platform 60
- C115** Elemento centrale cm
160
Central element cm 160
- C311 sx** Piano 103
Platform 103 left
- C303** Vassoio 97x97 bianco o
nero
Top 97x97 white/black

- C113** Elemento centrale cm
200
Central element cm 200
- C304 dx** Bracciolo 36
Arm 36 right

Composizione - Composition - Composition

Senza meccanismo schiena e senza base metallo
WITHOUT backrest mechanism and WITHOUT chrome-
plated bar

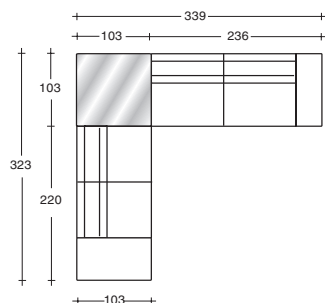

Gruppe - Composición 6/D

- C313 sx** Piano 60
Platform 60 left
- C294** Cuscino piano 60
Cushion for platform 60
- D115** Elemento centrale cm
160
Central element cm 160
- C311 sx** Piano 103
Platform 103 left
- C303** Vassoio 97x97 bianco o
nero
Top 97x97 white/black

- D113** Elemento centrale cm
200
entral element cm 200
- C304 dx** Bracciolo 36
Arm 36 right

Composizione - Composition - Composition

Meccanismo schiena e base metallo INCLUSO
Backrest mechanism and chrome-plated bar INCLUDED
in the price

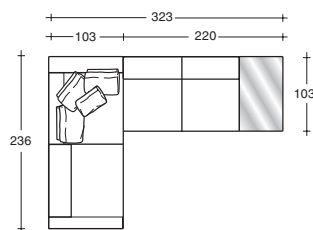

Gruppe - Composición 7/C

- C312 dx** Piano 60
Platform 60 right
- C302** Vassoio 97x54 bianco o
nero
Top 97x54 white/black
- C115** Elemento centrale cm
160
Central element cm 160
- C286 dx** Penisola cm 220
Peninsula cm 220 right
- C309 sx** Bracciolo 16
Arm 16 left

Composizione - Composition - Composition

Senza meccanismo schiena e senza base metallo
WITHOUT backrest mechanism and WITHOUT chrome-
plated bar

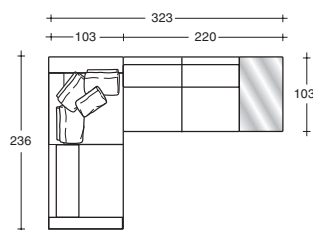

Gruppe - Composición 7/D

- C312 dx** Piano 60
Platform 60 right
- C302** Vassoio 97x54 bianco o
nero
Top 97x54 white/black
- D115** Elemento centrale cm
160
Central element cm 160
- D286 dx** Penisola cm 220
Peninsula cm 220 right
- C309 sx** Bracciolo 16
Arm 16 left

william

Composizione - Composition - Composition

Meccanismo schiena e base metallo INCLUSO
Backrest mechanism and chrome-plated bar INCLUDED
in the price

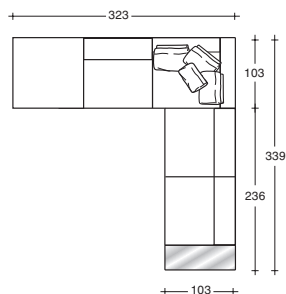

Gruppe - Composición 8/C

- C311 sx** Piano 103
Platform 103 left
- C293** Cuscino piano 103
Cushion for platform 103
- C286 dx** Penisola cm 220
Peninsula cm 220 right
- C113** Elemento centrale cm 200
Central element cm 200
- C314 dx** Piano 36
Platform 36 right

C301

Vassoio 97x30 bianco o nero
Top 97x30 white/black

Composizione - Composition - Composition

Senza meccanismo schiena e senza base metallo
WITHOUT backrest mechanism and WITHOUT chrome-plated bar

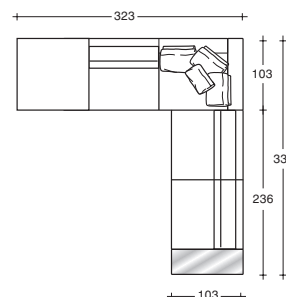

Gruppe - Composición 8/D

- C311 sx** Piano 103
Platform 103 left
- C293** Cuscino piano 103
Cushion for platform 103
- D286 dx** Penisola cm 220
Peninsula cm 220 right
- D113** Elemento centrale cm 200
Central element cm 200
- C314 dx** Piano 36
Platform 36 right

C301

Vassoio 97x30 bianco o nero
Top 97x30 white/black

Composizione - Composition - Composition

Meccanismo schiena e base metallo INCLUSO
Backrest mechanism and chrome-plated bar INCLUDED
in the price

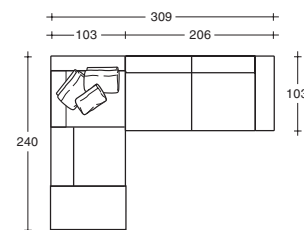

Gruppe - Composición 9/C

- C313 sx** Piano 60
Platform 60 left
- C294** Cuscino piano 60
Cushion for platform 60
- C290 dx** Penisola cm 180
Peninsula cm 180 right
- C114** Elemento centrale cm 180
Central element cm 180
- C306 dx** Bracciolo 26
Arm 26 right

Composizione - Composition - Composition

Senza meccanismo schiena e senza base metallo
WITHOUT backrest mechanism and WITHOUT chrome-plated bar

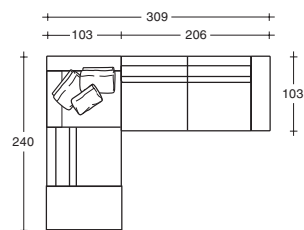

Gruppe - Composición 9/D

- C313 sx** Piano 60
Platform 60 left
- C294** Cuscino piano 60
Cushion for platform 60
- D290 dx** Penisola cm 180
Peninsula cm 180 right
- D114** Elemento centrale cm 180
Central element cm 180
- C306 dx** Bracciolo 26
Arm 26 right

william

Composizione - Composition - Composition

Meccanismo schiena e base metallo INCLUSO
Backrest mechanism and chrome-plated bar INCLUDED
in the price

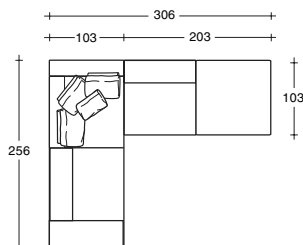

Gruppe - Composición 10/C

- C305 sx** Bracciolo 36
Arm 36 left
- C286 dx** Penisola cm 220
Peninsula cm 220 right
- C116** Elemento centrale cm 100
Central element cm 100
- C310 dx** Piano 103
Platform 103 right
- C293** Cuscino piano 103
Cushion for platform 103

Composizione - Composition - Composition

Senza meccanismo schiena e senza base metallo
WITHOUT backrest mechanism and WITHOUT chrome-plated bar

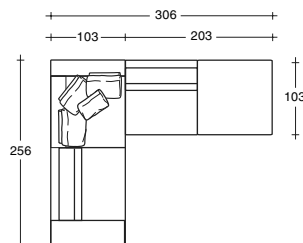

Gruppe - Composición 10/D

- C305 sx** Bracciolo 36
Arm 36 left
- D286 dx** Penisola cm 220
Peninsula cm 220 right
- D116** Elemento centrale cm 100
Central element cm 100
- C310 dx** Piano 103
Platform 103 right
- C293** Cuscino piano 103
Cushion for platform 103

Composizione - Composition - Composition

Meccanismo schiena e base metallo INCLUSO
Backrest mechanism and chrome-plated bar INCLUDED
in the price

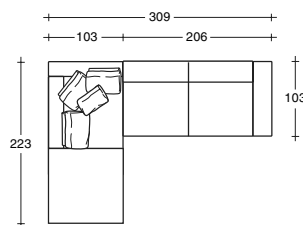

Gruppe - Composición 11/C

- C311 sx** Piano 103
Platform 103 left
- C293** Cuscino piano 103
Cushion for platform 103
- C292 dx** Penisola cm 120
Peninsula cm 120 right
- C114** Elemento centrale cm 180
Central element cm 180
- C306 dx** Bracciolo 26
Arm 26 right

Composizione - Composition - Composition

Senza meccanismo schiena e senza base metallo
WITHOUT backrest mechanism and WITHOUT chrome-plated bar

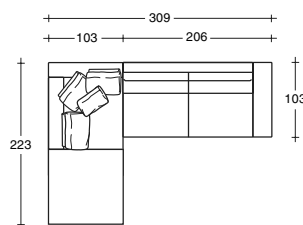

Gruppe - Composición 11/D

- C311 sx** Piano 103
Platform 103 left
- C293** Cuscino piano 103
Cushion for platform 103
- D292 dx** Penisola cm 120
Peninsula cm 120 right
- D114** Elemento centrale cm 180
Central element cm 180
- C306 dx** Bracciolo 26
Arm 26 right

william

Composizione - Composition - Composition

Meccanismo schiena e base metallo INCLUSO
Backrest mechanism and chrome-plated bar INCLUDED
in the price

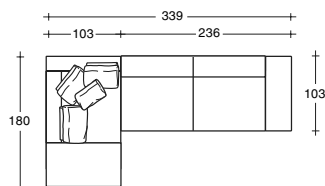

Gruppe - Composición 12/C

- C313 sx** Piano 60
Platform 60 left
- C294** Cuscino piano 60
Cushion for platform 60
- C292 dx** Penisola cm 120
Peninsula cm 120 right
- C113** Elemento centrale cm 200
Central element cm 200
- C304 dx** Bracciolo 36
Arm 36 right

Composizione - Composition - Composition

Senza meccanismo schiena e senza base metallo
WITHOUT backrest mechanism and WITHOUT chrome-plated bar

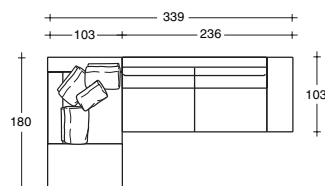

Gruppe - Composición 12/D

- C313 sx** Piano 60
Platform 60 left
- C294** Cuscino piano 60
Cushion for platform 60
- D292 dx** Penisola cm 120
Peninsula cm 120 right
- D113** Elemento centrale cm 200
Central element cm 200
- C304 dx** Bracciolo 36
Arm 36 right

Composizione - Composition - Composition

Meccanismo schiena e base metallo INCLUSO
Backrest mechanism and chrome-plated bar INCLUDED
in the price

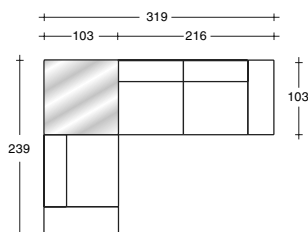

Gruppe - Composición 13/C

- C305 sx** Bracciolo 36
Arm 36 left
- C116** Elemento centrale cm 100
Central element cm 100
- C310** Piano 103
Platform 103
- C303** Vassoio 97x97 bianco o nero
Top 97x54 white/black
- C114** Elemento centrale cm 180
Central element cm 180

C304 dx Bracciolo 36
Arm 36 right

Composizione - Composition - Composition

Senza meccanismo schiena e senza base metallo
WITHOUT backrest mechanism and WITHOUT chrome-plated bar

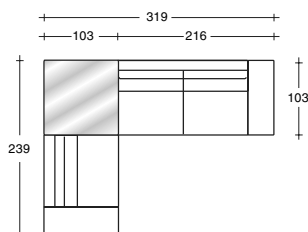

Gruppe - Composición 13/D

- C305 sx** Bracciolo 36
Arm 36 left
- D116** Elemento centrale cm 100
Central element cm 100
- C310** Piano 103
Platform 103
- C303** Vassoio 97x97 bianco o nero
Top 97x54 white/black
- D114** Elemento centrale cm 180
Central element cm 180

C304 dx Bracciolo 36
Arm 36 right